

# MAGNUSON GROUP

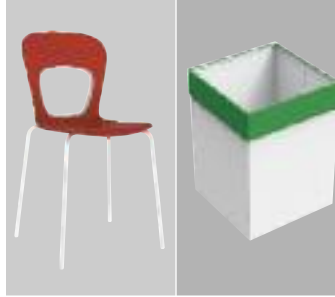

COMMERCIAL PRICE LIST  
AND SPECIFICATIONS  
EFFECTIVE JULY 1, 2016



# Introducing KASKAD

KASKAD is a family of planters that brings modularity, design and elegance to any space. Designed to stand alone or work together in combination, KASKAD serves as a flexible and highly adaptable planter solution. KASKAD is manufactured from powder-coated painted steel and available in 3 heights and 5 unique shapes – 1 square, 3 rectilinear and 1 parallelogram. Available in 3 finish colors – Textured White RAL 9010, Anodized Silver or Mineral Bronze – all KASKAD units come standard with adjustable glides and a removable liner for plant material. KASKAD planters are for indoor use. Designed by QDesign. Made in the USA.





# Magnuson Makes It Easy

## Online Resources

---



Product Information – Find images, inspiration and more on our website.



Price List – Find US & Canadian pricing online; GSA Advantage & NCPA pricing also available.



Product Animations – These short, catchy videos bring our products to life –check them out!



Downloadable PDFs – Download or share Price Lists, Quick Reference Guide or Product Overview PDFs



Pinterest – Our Pinterest site has high-resolution images, install shots and inspiration for your office!



CAD & Revit Symbols – Request CAD or Revit symbols on our website for space planning.

## Factory Resources

---



Product Samples – Order discounted product samples for your evaluation and use.



Merchandise Mart Showroom – If you're in Chicago, make an appointment to come see us!



Customer Service – Our friendly, helpful & knowledgeable staff is standing by to help.



Literature – All our printed literature is available for free upon request for you or your clients.

## Industry Resources

---

Magnuson Group has partnered with some of the industry's best to ensure our products are easy to access, specify and purchase.





RIVISTA



NEW WAVE

NEW PORT

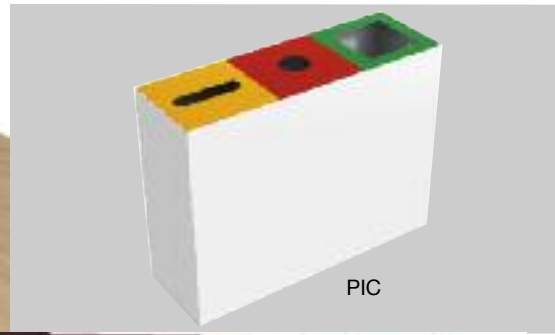

PIC



TRADA-STEP



KASKAD



NEW PORT



HOLD

STORE



ISIDORO



STILLY



SUM TOOL RAIL



STILO



KASKAD



CONEE

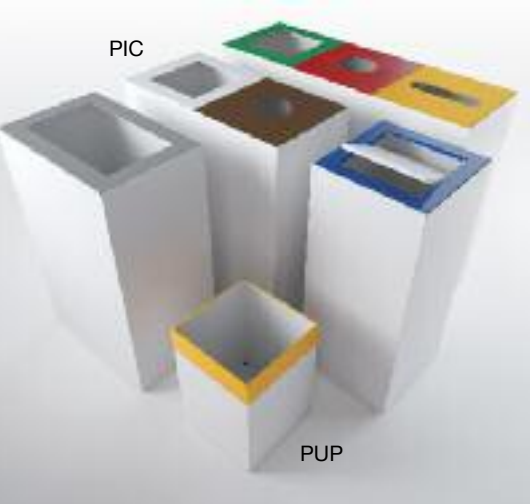

PIC

PUP



STORE



SOU



NEW PORT



RIVISTA



NEW PORT



NEW WAVE



STICKS FM



STILLY



NINO



HELIX JR



PUP



ROLLER



ISIDORA



HOLD-DAILY



SOU



ISIDORO



HOLD-DAILY



NINO



STILO

# Quick Ship in 5 Days or Less

## Bold is Fastest

A number of models and finishes of the products reflected on this page ship in 5 days or less. Please refer to the page referenced below for these specific products, models and finishes—identified in **bold print**—that qualify for Quick Ship.

(Please refer to page 7 for the Quick Ship Program Terms & Conditions.)

## Coat Racks

- Linea (page 118)
- Office Rak (page 118)
- Rap Rak (page 118)
- CLM Series (page 117)
- DS Series (page 116, 119)

## Coat Trees

- PC Series (page 112)
- MET, MKT, MBT (page 113)
- PC Wall Series (page 107)

## Hook Panels, Hook Strips, Hooks & Hangers

- Stainless Steel Series (page 109)
- K Series Hooks (page 105, 106)
- Molded Polystyrene Hangers (page 122)
- Wood Hangers (page 122)
- Steel Hangers (page 121)

## Magazine Racks/Chart Holders

- 2000 Series (page 80)
- 7000 Series (page 82)

## Freight is Quick and Easy

### Two Easy Options

There are two simple ways to price freight on your order:

#### 1. EZ Freight:

- (a) Simply calculate 8% of the Total Order/List Price;
- (b) Note "EZ Freight" on the PO. (Available in Continental US only; minimum order of \$200 List; standard delivery applies.) Truck minimum applies.

#### 2. Freight Quote:

- (a) Simply call us at 1-800-342-5725 and we'll calculate your freight quote on the spot;
- (b) Note "Freight Quote" on the PO

(Please refer to page 7 for the EZ Freight Program Terms & Conditions, and an example of how to calculate using this method.)

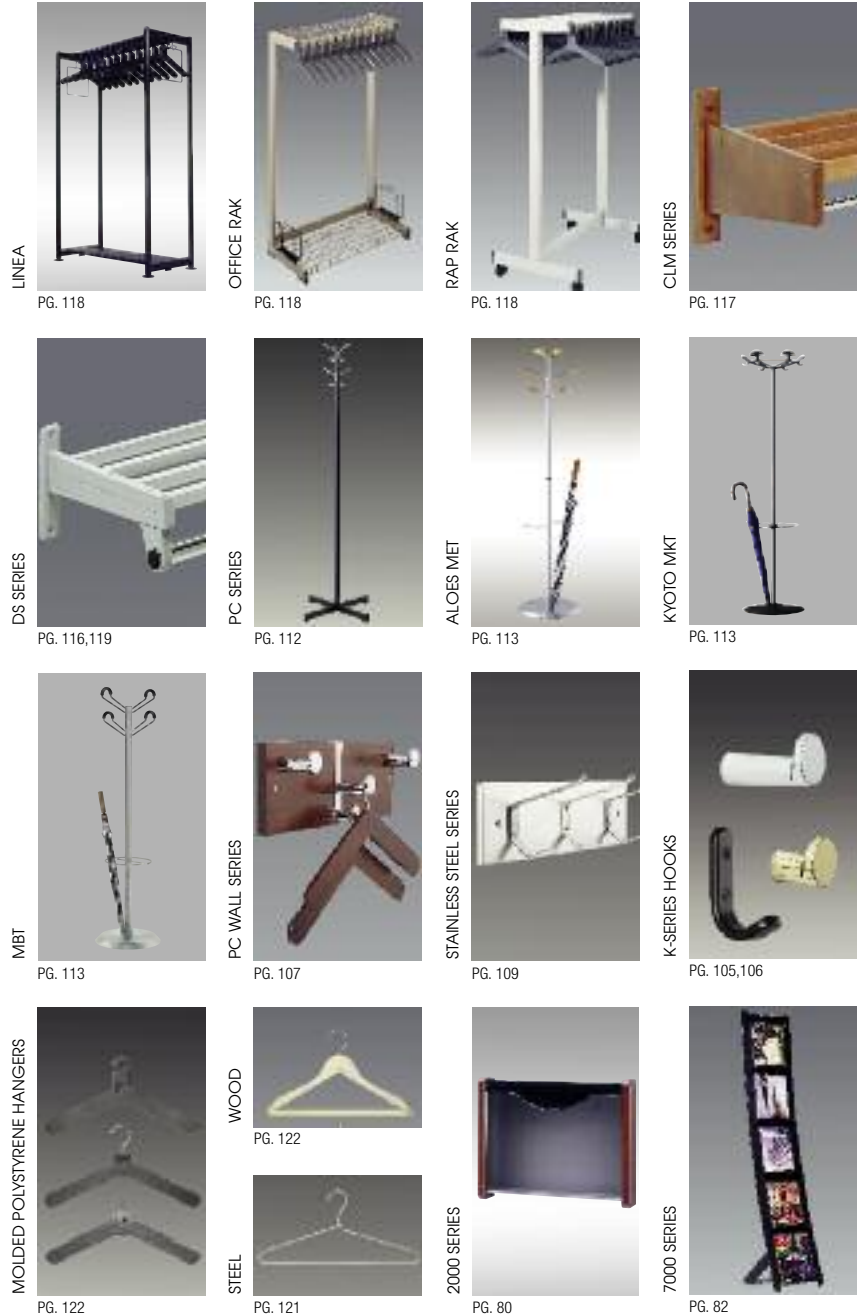

**Cash Terms:** Net 30 days. A service charge of 1% per month will be assessed on all past due accounts. Custom orders will require a deposit in advance.

First orders by new accounts will be on VISA, MasterCard, Discover, American Express or check in advance. Open accounts may be established upon submission and approval of three trade references and bank information.

**Custom Orders:** All custom orders require a 50% non-refundable deposit of the total quoted price. The order will not be processed until the deposit is received.

**Non-Stock Orders:** All orders for items that are not in stock may require a 50% non-refundable deposit at time of order placement. The order will not be processed until the deposit is received.

**Large Orders:** Orders over \$10,000 net may require a 25% deposit at time of order placement.

**Mail, E-Mail and Fax Orders:** Mail, E-mail, and fax are the only acceptable methods of placing orders. If a confirming order is sent, it must be marked "CONFIRMING ORDER". Duplicate orders not marked "CONFIRMING ORDER" are the responsibility of the buyer.

**Order Acknowledgement:** Magnuson Group will confirm the buyers purchase order.

**Delays in Delivery:** Magnuson Group will not be held liable for failure to ship or deliver on or by any particular date.

**Freight Classification:** Classification can vary greatly based upon what and how much is ordered.

**Freight Terms:** F.O.B. Woodridge, Illinois. Freight charges are prepaid and added to invoice at time of shipment unless 3rd party billing is specified on the order.

**Quick Ship Program:** Items/colors in **bold print** ship in 5 working days. Quantity is limited to 10 units or less. Quickship items must be on separate P.O. form from standard lead time items.

**Title to Merchandise:** Once Magnuson Group delivers the product to the carrier, title to the merchandise and risk of loss passes to the buyer. We are not responsible for loss or damage during transit. All freight claims are the responsibility of the purchaser or consignee.

**Shipping Damage/Shortage Claims:** All shipments should be inspected carefully on delivery, and any apparent damage or shortages noted as exceptions on all copies of the delivery receipt. Notification of shortages or concealed damage must be made to the delivering carrier within 3 days of receipt.

Claims of either visible or concealed damage should be presented without delay to the carrier by the consignee.

**Shortage Claims:** Shortage claims reported 30 days beyond shipment date will not be honored.

**Routing:** UPS or Federal Express Ground will be used where size and weight restrictions allow. On larger shipments common carrier will be used.

**Order Changes:** Changes to orders in process are subject to approval and to the same conditions as cancellations.

**Cancellations and Returns:** Orders in any stage of processing and production may not be cancelled without authorization in writing from Magnuson Group and may be subject to a 50% cancellation fee. If a return is authorized, a minimum restocking charge of 30% will be incurred, return freight pre-paid. Returned goods must be unused and packaged in original cartons within 90 days of original shipping date. Custom orders cannot be returned. Credit will be issued subject to inspection by our receiving department.

**Price and Design Changes:** All prices are subject to change without notice and prices in effect at time of shipment will prevail. Magnuson Group reserves the right to improve product design, construction and quality without notice. EZ Freight program is subject to change without notice.

**Warranty:** All products and parts are warranted against defects in material and workmanship for the period of (2) years after shipment. Warranty is void if product is damaged through accident, improper use, abuse, or alteration.

**Limitation of Liability:** Magnuson Group's liability for any and all losses and damages to buyer resulting from any cause shall be limited only to the replacement or the repair of the product.



**For Your Convenience:** As an alternative to cash terms, we accept Visa, MasterCard, Discover and American Express.

**Save on Shipping Costs:** Many items in this line qualify for United Parcel Service routing.

**Visit us at our Web Site:** [www.magnusongroup.com](http://www.magnusongroup.com)



GSA-We are a multiple contract holder with GSA. Please contact us for information.



## E-Z FREIGHT PROGRAM

Magnuson Group now offers two options for calculating freight charges.

**Option One:** Calculate your freight charges using E-Z Freight as follows: Add 8% of the **total order list price** for all products to calculate the freight charge.

**Example:** 3 OR4A @ \$655.00 = \$1,965.00  
1 DS4H @ \$226.00 = \$226.00  
**\$2,191.00**

**Total List:** **\$2,191.00** x 8% = **\$175.28**

Enter this amount on your order as E-Z Freight.

If E-Z Freight is not noted on your Purchase Order, actual freight will be charged. E-Z Freight applies to the 48 continental states only. Your order must be at least \$200 list to use this program.

**A minimum charge of \$145.00 for truck shipments applies.**

E-Z Freight calculations are for normal dock delivery only and do not include accessororial charges, such as "Call Before Delivery", "Inside Delivery", etc. which will be billed in addition to the E-Z Freight charges. Contact Customer Service for more information.

**Option Two:** Contact Customer Service at 800-342-5725 for a freight quote. Note the freight amount on your purchase order.

UPS and UPS in shield design are registered trademarks of United Parcel Service of America, Inc. Used by permission.



VALUTA



SOTARE



SLOPE



UMEA



STORLEK



STILO



TRADA-STEP



TRADA



RIGA



PIC



ZURICH



DROP



SILO



PUP



MY PERSONAL RECYCLER



SORTMATE



CONEE



AXIANE



BASICS



RETTO



LAUSANNE



BALLOON



MECORA



SMOKE



# TABLE OF CONTENTS

## ACOUSTIC WALL PANELS

STILLY.....	75
-------------	----

## BROCHURE & LEAFLET HOLDERS

COMPACT SOISTES.....	75,84
DACAPO.....	76
DACAPO IPOINT.....	77
FLIP.....	75,84
SOLID ZIP.....	77

## COAT HANGERS & RECEPTACLES

FLO.....	121
HANGER RECEPTACLES.....	122
MIRAC.....	121
MOLDED POLYSTYRENE.....	122
PI.....	121
STEEL.....	121
WOOD.....	122

## COAT HOOKS, HOOK PANELS & HOOK STRIPS

ALOES MEW SERIES.....	108
BAMBU.....	105
CIRCUS.....	104
CLIMB.....	110
K SERIES.....	105,106
K SERIES HOOK PANELS.....	106
KOBE SERIES.....	108
KYOTO MKW SERIES.....	108
MIRAC.....	104,110
MPAM SERIES.....	109
ONA.....	109
PC550 SERIES.....	107
PC SERIES PANEL OR DOOR.....	107
POINTO.....	105
SEI.....	110
STAINLESS STEEL SERIES.....	109
STICKS HJH.....	110
STICKS FM.....	104
TERTIO H.....	111
TERTIO HA.....	111
TERTIO HD.....	111
TERTIO HJH.....	111
TERTIO H-K.....	107
TREEHOOKED.....	104
TUBULUS H.....	104
YIN MYIW SERIES.....	108
YIN UNDER TABLE PURSE HOOK.....	104

## COAT HOOKS MAGNETIC

KOBE-MA.....	103
MEM.....	103
MKM.....	103
MPA-MA.....	103
MPIM.....	103
MYIM.....	103
NINO.....	104
OLEA-MA.....	103
STICKS-MA.....	103
TERTIO MAGNETIC.....	102

## COAT RACKS - FREE STANDING & MOBILE

ARNAGE.....	121
DS SERIES.....	119
LINEA.....	118
MEGA RAK.....	120
OFFICE RAK.....	118
RAP RAK.....	118
SHERLO.....	121
TERTIO.....	120

## COAT RACKS - WALL MOUNTED

ARNAGE.....	117
CLM SERIES.....	117
DS SERIES.....	116
TERTIO W/K.....	117
TERTIO W2.....	117

## COAT TREES

ALOES MET SERIES.....	113
BAMBU.....	112
BRANCH.....	115
EWC SERIES.....	112
HELIX SERIES.....	115
HULOT.....	114
JUNO.....	112
KOBE.....	113
KYOTO MKT.....	113
MARS+.....	112
MBT.....	113
MIRAC.....	114
PALADINO.....	114
PC SERIES.....	112
PI.....	114
SAGITTA.....	114
SECOND TREE.....	115
STICKS G+.....	114
TAIGA.....	115

## COAT TREES

XYLO SERIES.....	113
YIN.....	113

## CROWD CONTROL STANCHIONS

STOPPER ECO.....	101
TEMPALINE.....	100

## DESKTOP ACCESSORIES

AXIANE.....	61
PHONE/TABLET & LAPTOP SUPPORTS.....	62
NEWPORT.....	55,56,57
NEW WAVE.....	58,59
REST.....	60
SUM TOOL RAILS.....	55

## FOOTRESTS

RELAX.....	65
------------	----

## IPAD DISPLAYS

PADFIX.....	95
PADLINE.....	95

## INFORMATION & GRAPHIC DISPLAYS

CLAMPER.....	86
FLIP.....	75,84
GLASSNOX.....	87,88,89,94
IFLAG.....	83,87
INFOGLASS.....	89,94
INFOMERA.....	86
PANTALLA.....	85
SNAPREX.....	85,94

## MAGAZINE & LITERATURE DISPLAYS

1000 SERIES.....	78
2000 SERIES.....	79
2000 SERIES CHART HOLDERS.....	80
7000 SERIES.....	82
COMPACT SOISTES.....	75,84
CUBIC SOISTES.....	81
FLAP.....	83
IFLAG.....	83,87
KOKU.....	82,100
RACK SOISTES.....	81
SCOOP.....	82
USIO.....	83,100
VOICI.....	82
WALLMATE SOISTES.....	81
ZIN.....	84

## MESSAGE BOARDS

CARTBOX.....	95,96
MAGO MAGNEEDOOR.....	96

## MOVEABLE SCREENS

KP+.....	97
MALVA.....	97

## OUTDOOR ASHTRAYS

FUM.....	74
RIGA.....	37,74
SMOKE.....	44,74
VESUVIO.....	74

## OUTDOOR SEATING & TABLES

CALMA.....	65,70
CELES.....	68,73
FLOD.....	65,70
ISIDORA.....	71
ISIDORO.....	67,70
LUCIDO.....	71
OM BASIC.....	71
OXI BISTROT.....	69,73
RIVISTA CHAIR.....	72
RIVISTA STOOL.....	66,70
STEP.....	69,72
STILLA CHAIR.....	72
STILLA TABLES.....	72
VACANZA.....	71

## PLANTERS

CONEE.....	52
CREPE.....	50
GREEN CLOUD.....	51
KASKAD.....	49
KYO.....	50
LAURA.....	50,68
STILO.....	52

## POSTER DISPLAYS

ARNAGE.....	94
GLASSNOX.....	87,88,89,94
INFOGLASS.....	89,94
LUMO.....	90
LUMO IPOINT.....	90
MAGINFO SLIM SOISTES.....	93
MAGINFO SOISTES.....	93

## POSTER DISPLAYS

MAGNEEDOOR.....	91
MAGNEEDOOR SLIM.....	92
SNAPREX.....	85,94

## SHELVING/BOOKSHELVES

KOKU.....	82,100
TOTEM.....	99
USIO.....	83,100

## SHOWCASES

PICTOR.....	98
-------------	----

## SORTING MODULES

POSTCLASS.....	102
----------------	-----

## STOOLS

CALMA.....	65,70
FLOD.....	65,70
GINLET.....	66
ISIDORO.....	67,70
NUTA.....	66
RIVISTA.....	66,70
ZED.....	65

## TABLES - CAFÉ & OCCASIONAL

CELES.....	68,73
COOLTIME.....	67
LAURA.....	50,68
MILL.....	68
OXI BISTROT.....	69,73
STEP.....	69,72

## UMBRELLA STANDS

BAYU 2.....	123
CONEE.....	125
DRIP.....	124
DROP IN.....	124
FORREIN.....	124
MCU.....	124
P70/P100.....	123
PLATEA.....	124
RIGA.....	123
SILO.....	124
SOU.....	125
TAIGA.....	123
YIN.....	123

## WASTE & RECYCLING RECEPTACLES - DESK SIDE

AXIANE.....	43,61,64
BASICS.....	42,63
CONEE.....	44,62
DROP.....	43,64
MY PERSONAL RECYCLER.....	43,64
PUP.....	44,62
SILO.....	43,64
SORTMATE.....	42,63

## WASTE & RECYCLING RECEPTACLES - INTERIOR SPACES

PIC.....	39,40
RIGA.....	36,37,44,74
SLOPE.....	24,25,26
SLOPE JR.....	27,28,29
SOTARE.....	22,23
STILO.....	41
STORLEK.....	30,31
TRADA.....	38
UMEA.....	32,33,34,35
VALUTA.....	20,21
VALUTA JR.....	20,21
ZURICH.....	41

## WASTE & RECYCLING RECEPTACLES - EXTERIOR SPACES

BALLOON.....	45
LAUSANNE.....	46
MECORA.....	46
RETTO.....	44
RIGA.....	36,37,44,74
SMOKE.....	44,74
UMEA.....	47,48

## WHITE BOARDS

ARNAGE.....	96
-------------	----

## WORKSPACE & COLLABORATIVE CARTS

HOLD.....	53
HOLD BOX.....	54
HOLD DAILY.....	54
ROLLER.....	54
STORE.....	52

PRODUCT PREFIX INDEX.....	126,127,128
---------------------------	-------------

SUSTAINABILITY STATEMENT.....	129
-------------------------------	-----

Please see pages 10 - 19 for the corresponding product pictorial table of contents.

Bold items contain some quick ship products. See product for details.

WASTE & RECYCLING RECEPTACLES INTERIOR SPACES >



VALUTA / VALUTA JR.

PG. 20,21



SOTARE

PG. 22,23



SLOPE

PG. 24,25,26



SLOPE JR.

PG. 27,28,29



STORLEK

PG. 30,31



UMEA

PG. 32,33,34,35

WASTE & RECYCLING RECEPTACLES INTERIOR SPACES >



RIGA

PG. 36,37,44,74



TRADA-STEP

PG. 38



PIC

PG. 39,40



STILO

PG. 41



ZURICH

PG. 41



SORTIMATE

PG. 42,63

WASTE & RECYCLING RECEPTACLES INTERIOR SPACES >



BASICS

PG. 42,63



AXIANE

PG. 43,61,64



SILO

PG. 43,64



DROP

PG. 43,64



MY PERSONAL RECYCLER

PG. 43,64



PUP

PG. 44,62

WASTE & RECYCLING RECEPTACLES INTERIOR SPACES

WASTE & RECYCLING RECEPTACLES EXTERIOR SPACES >



CONEE

PG. 44,62



SMOKE

PG. 44,74



RIGA

PG. 36,37,44,74



RETTO

PG. 44



BALLOON

PG. 45



MECORA

PG. 46

WASTE & RECYCLING EXTERIOR SPACES

PLANTERS >



LAUSANNE

PG. 46



UIMEA

PG. 47,48



KASKAD

PG. 49



KYO

PG. 50



CREPE

PG. 50



LAURA

PG. 50,68

PLANTERS

WORKSPACE & COLLABORATIVE CARTS >



GREEN CLOUD

PG. 51



CONEE

PG. 52



STILO

PG. 52



STORE

PG. 52



HOLD

PG. 53



HOLD-DAILY DR

PG. 54

WORKSPACE & COLLABORATIVE CARTS

DESKTOP ACCESSORIES >



ROLLER

PG. 54

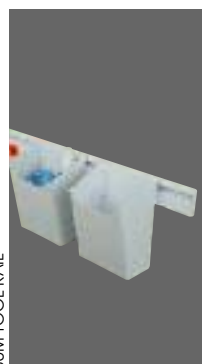

SUM TOOL RAIL

PG. 55



NEW PORT

PG. 55,56,57



NEW WAVE

PG. 58,59



REST

PG. 60



AXIANE

PG. 43,61,64

DESKTOP ACCESSORIES

WASTE & RECYCLING RECEPTACLES DESKSIDE



LAPTOP SUPPORT

PG. 62



PHONE SUPPORT

PG. 62



TABLET SUPPORT

PG. 62



PUP

PG. 44,62



CONEE

PG. 44,62



SORTIMATE

PG. 42,63

WASTE & RECYCLING RECEPTACLES DESKSIDE

FOOTRESTS



BASICS

PG. 42,63



AXIANE

PG. 43,61,64



SILO

PG. 43,64



DROP

PG. 43,64



MY PERSONAL RECYCLER

PG. 43,64



RELAX

PG. 65

STOOLS >



FLOD

PG. 65,70



CALMA

PG. 65,70



ZED

PG. 65



VENT

DISCONTINUED



GINLET

PG. 66



NUVA

PG. 66

STOOLS

TABLES - CAFÉ & OCCASIONAL >



RIVISTA

PG. 66,70



ISIDORO

PG. 67,70



COOLTIME TABLES

PG. 67



MILL

PG. 68



CELES

PG. 68,73



LAURA

PG. 50,68

TABLES - CAFÉ & OCCASIONAL

OUTDOOR SEATING & TABLES >



OXI BISTROT

PG. 69,73



STEP

PG. 69,72



FLOD

PG. 65,70



CALMA

PG. 65,70



RIVISTA

PG. 66,70



ISIDORO

PG. 67,70

OUTDOOR SEATING & TABLES ▶



LUCIDO

PG. 71



SIDORA

PG. 71



OM BASIC

PG. 71



VACANZA

PG. 71



STILLA

PG. 72



RIVISTA

PG. 72

OUTDOOR SEATING & TABLES

OUTDOOR ASHTRAYS ▶



STILLA

PG. 72



STEP

PG. 69,72



CELES

PG. 68,73



OXI BISTROT

PG. 69,73



FUM

PG. 74



RIGA ASH

PG. 37,74

OUTDOOR ASHTRAYS

ACOUSTIC WALL PANELS

BROCHURE & LEAFLET HOLDERS ▶



SMOKE

PG. 44,74



VESUVIO

PG. 74



STILLY

PG. 75



COMPACT SOISTES

PG. 75,84



FLIP

PG. 75,84



DACAPO

PG. 76

BROCHURE & LEAFLET HOLDERS

MAGAZINE & LITERATURE DISPLAYS ▶



DACAPO IPOINT

PG. 77



SOLID ZIP

PG. 77



1000 SERIES

PG. 78



2000 SERIES/CHART HOLDERS

PG. 79,80



RACK SOISTES

PG. 81



CUBIC SOISTES

PG. 81

MAGAZINE & LITERATURE DISPLAYS ▶



WALLMATE SOISTES

PG. 81



7000 SERIES

PG. 82



SCOOP

PG. 82



KOKU

PG. 82,100



VOICI

PG. 82



FLAP

PG. 83

MAGAZINE & LITERATURE DISPLAYS

INFORMATION & GRAPHIC DISPLAYS ▶



IFLAG

PG. 83,87



USIO

PG. 83,100



ZIN

PG. 84



COMPACT SOISTES

PG. 75,84



PANTALLA

PG. 85



SNAPREX

PG. 85,94

INFORMATION & GRAPHIC DISPLAYS



CLAMPER

PG. 86



INFOMERA SERIES

PG. 86



IFLAG

PG. 83,87



GLASSNOX

PG. 87,88,89,94



INFOGLASS

PG. 89,94



FLIP

PG. 75,84

POSTER DISPLAYS



LUMO

PG. 90



LUMO IPOINT

PG. 90



MAGNEODOOR

PG. 91



MAGNEODOOR SLIM

PG. 92



MAGINFO SOISTES

PG. 93



MAGINFO SLIM SOISTES

PG. 93

POSTER DISPLAYS

IPAD DISPLAYS



INFOGLASS

PG. 89,94



SNAPREX

PG. 85,94



GLASSNOX

PG. 87,88,89,94



ARNAGE POSTER DISPLAY

PG. 94



PADLINE

PG. 95



PADFIX

PG. 95

MESSAGE BOARDS

WHITEBOARDS

MOVEABLE SCREENS

SHOWCASES



CARIBOX

PG. 95,96



MAGO MAGNEODOOR

PG. 96



ARNAGE WHITEBOARD

PG. 96



KP+

PG. 97



MALVA

PG. 97



PICTOR

PG. 98

SHELVING / BOOKSHELVES

CROWD CONTROL STANCHIONS

SORTING MODULES



TOTEM

PG. 99



KOKU

PG. 82,100



USIO

PG. 83,100



TEMPALINE

PG. 100



STOPPER ECO

PG. 101



POST CLASS

PG. 102

COAT HOOKS MAGNETIC ▶



TERTIO MAGNETIC

PG. 102



MPIM

PG. 103



MKM

PG. 103



MEM

PG. 103



MYIM

PG. 103



MPA-MA

PG. 103

COAT HOOKS MAGNETIC

COAT HOOKS, HOOK PANELS, & HOOK STRIPS



OLEA MA

PG. 103



KOBE MA

PG. 103



STICKS MA

PG. 103



NINO

PG. 104



YIN PURSE HOOK

PG. 104



TUBULUS H

PG. 104

COAT HOOKS, HOOK PANELS & HOOK STRIPS



STICKS FM

PG. 104



TREEHOOKED

PG. 104



CIRCUS

PG. 104



MIRAC

PG. 104



BAIMBU

PG. 105



PUNTO

PG. 105

COAT HOOKS, HOOK PANELS & HOOK STRIPS



K SERIES

PG. 105,106



K SERIES HOOK PANELS

PG. 106



PC PANEL DOOR SERIES

PG. 107



PC 550 SERIES

PG. 107

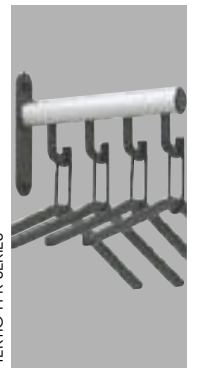

TERTIO H-K SERIES

PG. 107



KYOTO MKW SERIES

PG. 108

COAT HOOKS, HOOK PANELS & HOOK STRIPS

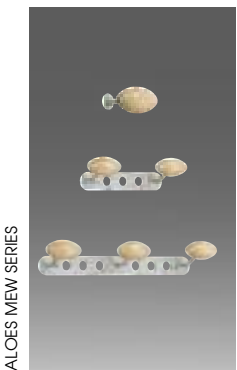

ALOES MEW SERIES

PG. 108



YIN MYW SERIES

PG. 108

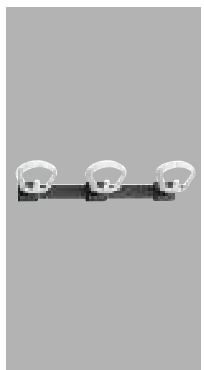

KOBE SERIES

PG. 108



MPAM SERIES

PG. 109



STAINLESS STEEL SERIES

PG. 109



ONA

PG. 109



COAT HOOKS, HOOK PANELS & HOOK STRIPS

COAT TREES ▶



COAT TREES ▶



COAT TREES ▶

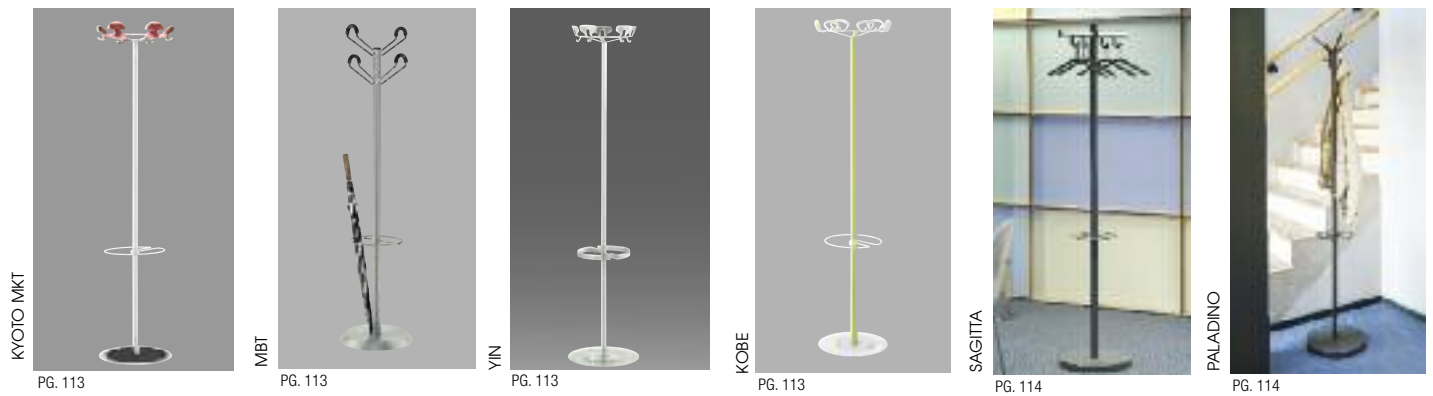

COAT TREES ▶



COAT TREES

COAT RACKS WALL MOUNTED ▶

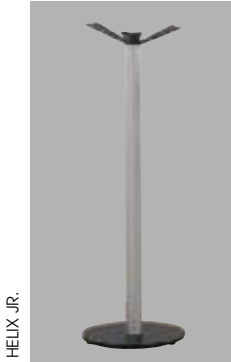

HELIX JR.

PG. 115

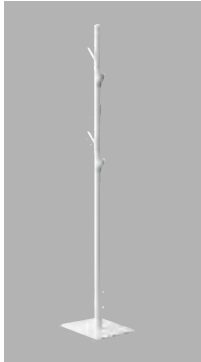

BRANCH

PG. 115



SECOND TREE

PG. 115



DS SERIES

PG. 116



ARNAGE

PG. 117



TERTIO

PG. 117

COAT RACKS WALL MOUNTED

COAT RACKS - FREE STANDING & MOBILE ▶



CLM SERIES

PG. 117



LINEA

PG. 118



OFFICE RAK

PG. 118



RAP RAK

PG. 118



DS SERIES

PG. 119



TERTIO

PG. 120

COAT RACKS - FREE STANDING & MOBILE

COAT HANGERS & RECEPTACLES ▶



MEGA RAK

PG. 120

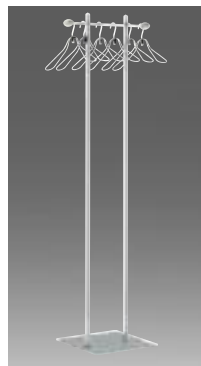

SHERLO

PG. 121

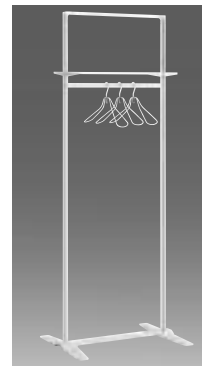

ARNAGE

PG. 121



MIRAC

PG. 121



FILO

PG. 121



PI

PG. 121

COAT HANGERS & RECEPTACLES

UMBRELLA STANDS ▶



STEEL

PG. 121



MOLDED POLYSTYRENE

PG. 122



WOOD

PG. 122



P70/P100

PG. 123



BAY02

PG. 123

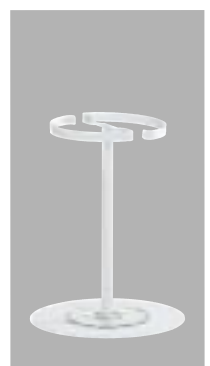

YIN

PG. 123

## UMBRELLA STANDS >



RIGA

PG. 123



TAIGA

PG. 123



SILO

PG. 124



DRIP

PG. 124



MCU

PG. 124



PLATEA

PG.124

## UMBRELLA STANDS



FORREIN

PG. 124

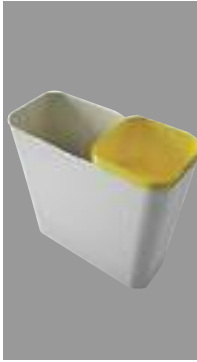

DROP IN

PG. 124



CONEE

PG. 125



SOU

PG. 125

# VALUTA™ JR.

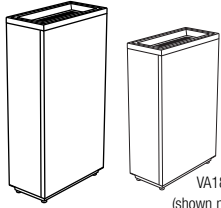

VA1809L-JR  
(shown next to VA1809L for height comparison)

MODEL	H	W	D	SHIPPING WEIGHT	DESCRIPTION	COLOR/ FINISH	LIST PRICE
VA1809L-JR	26 1/8"	9"	18"	30 lbs.†	14 gallon unit with internal rigid liner junior height	Dark Anthracite, Anodized Silver, Lunar White, Bronze Metallic	\$720.00

# VALUTA™

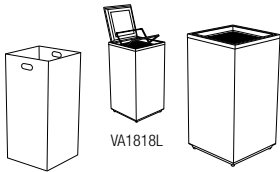

VA1818L

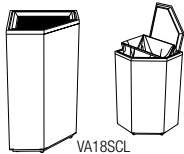

VA18SCL

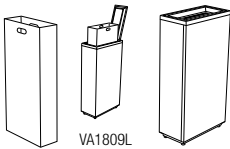

VA1809L

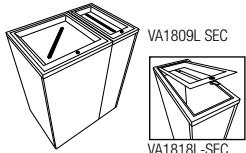

VA1809L-SEC

VA1818L-SEC

MODEL	H	W	D	SHIPPING WEIGHT	DESCRIPTION	COLOR/ FINISH	LIST PRICE
VA1818L	33 3/4"	18"	18"	54 lbs.†	40 gallon unit with internal rigid liner	Dark Anthracite, Anodized Silver, Lunar White, Bronze Metallic	\$965.00
VA18SCL	33 3/4"	18"	18"	50 lbs.†	35 gallon unit with internal rigid liner	Dark Anthracite, Anodized Silver, Lunar White, Bronze Metallic	\$985.00
VA1809L	33 3/4"	9"	18"	34 lbs.†	20 gallon unit with internal rigid liner	Dark Anthracite, Anodized Silver, Lunar White, Bronze Metallic	\$765.00
VA1818L-SEC	33 3/4"	18"	18"	54 lbs.†	40 gallon unit with internal rigid liner, locking top with slot for secure document disposal.	Anodized Silver top only. Body in Anodized Silver or Dark Anthracite	\$1,045.00
VA1809L-SEC	33 3/4"	9"	18"	34 lbs.†	20 gallon unit with internal rigid liner, locking top with slot for secure document disposal.	Anodized Silver top only. Body in Anodized Silver or Dark Anthracite	\$835.00

Internal bag holding system w/liner is standard on all Valuta models

VALUTA is available with four different top configuration options for each size model.



### 40 Gallon Unit/Top Configuration Options

Waste opening	Paper opening	Cans/Plastic/Glass opening	Paper/circle opening
11-1/16" x 11-1/16"	2" x 15-5/8"	4-1/4" diameter	2"x 15-5/8" 4 1/4" diameter

### 14 & 20 Gallon Unit/Top Configuration Options

Waste opening	Paper opening	Cans/Plastic/Glass opening	Paper/circle opening
4-1/4" x 13-3/16"	2" x 12"	4-1/4" diameter	2"x 12" 4 1/4" diameter circle opening

### 35 Gallon Unit/Top Configuration Options

Waste opening	Paper opening	Cans/Plastic/Glass opening	Paper/circle opening
11-1/16" x 11-1/16"	2" x 15-5/8"	4-1/4" diameter	2"x 15-5/8" 4 1/4" diameter opening

VALUTA BODIES AND TOPS ARE EACH AVAILABLE IN THE FOLLOWING POWDER COAT PAINT COLORS:



Dark Anthracite



Anodized Silver



Lunar White



Bronze Metallic

† Ships via common carrier

Valuta bodies & tops are available in special order, non-standard powder coat paint colors for additional cost as follows:

Paint Manufacturer/ Color Series	Minimum Order Quantity	Additional Cost 40 Gallon Units	Additional Cost 35 Gallon Units	Additional Cost 14 & 20 Gallon Units	Lead Time
Contact Customer Service for Details	50 units (per each color)	\$85 List per unit	\$85 List per unit	\$65 List per unit	6-8 Weeks

Valuta is available with eight optional icon/references for easy sorting and disposal of various types of waste as follows:



**\*Dark Anthracite, Anodized Silver and Bronze Metallic body colors come standard with a White Icon / Reference label; Lunar White body color is standard with a Dark Gray Icon / Reference label. Valuta icons for each of the above references are also available in the following colors for a \$22.00 up charge per icon. Specify icon reference and color on order. ( ie. Waste icon in Saddle Brown )**

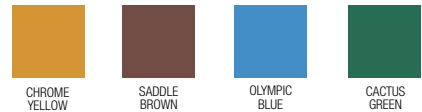

## How to order Valuta

When ordering Valuta, a selection must be made from each column below and noted on the order [see example below]

Valuta Model	Selection #1 Body Color Choice*	Selection #2 Top Color Choice	Selection #3 Top Configuration Choice	Selection #4 Icon / Reference Choice	Selection #5 Icon / Reference Placement
VA1818L (40 Gallon Unit)	Dark Anthracite, Anodized Silver, Bronze Metallic, Lunar White	Dark Anthracite, Anodized Silver, Bronze Metallic, Lunar White	Waste, Paper, Cans/Plastic/Glass, Paper/Circle Combo	Waste, Paper, Recycling, Cans, Plastic, Glass, Organics, Recycling Arrows	Ref 1,2,3,4 (see diagram below for key)
VA1809L (20 Gallon Unit) VA 1809LJR (14 Gallon Unit)	Dark Anthracite, Anodized Silver, Bronze Metallic, Lunar White	Dark Anthracite, Anodized Silver, Bronze Metallic, Lunar White	Waste, Paper, Cans/Plastic/Glass, Paper/Circle Combo	Waste, Paper, Recycling, Cans, Plastic, Glass, Organics, Recycling Arrows	Ref 1,2,3,4 (see diagram below for key)
VA18SCL (35 Gallon Unit)	Dark Anthracite, Anodized Silver, Bronze Metallic, Lunar White	Dark Anthracite, Anodized Silver, Bronze Metallic, Lunar White	Waste, Paper, Cans/Plastic/Glass, Paper/Circle Combo	Waste, Paper, Recycling, Cans, Plastic, Glass, Organics, Recycling Arrows	Ref 1,2,3,4,5 (see diagram below for key)

## Icon/ Reference Placement

Each Valuta includes (1) one Icon/Reference per unit. Per the diagram below, please indicate the desired placement/orientation of the label (i.e., the correct side of the body). Additional Icon/References are available for additional cost. Contact Customer Service for more information.



**40 Gallon Unit**

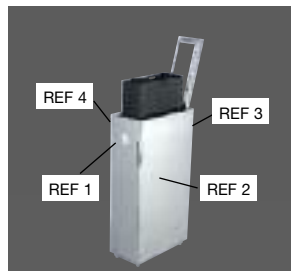

**14 & 20 Gallon Unit**

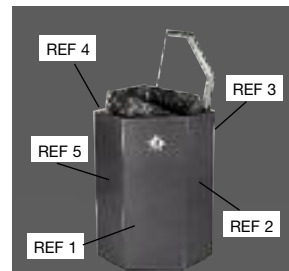

**35 Gallon Unit**

### 40/20/14 Gallon Unit Key:

- REF 1: Icon placed on "FRONT" (side opposite hinged top)
- REF 2: Icon placed on "RIGHT SIDE"
- REF 3: Icon placed on "REAR" (same side as hinged top)
- REF 4: Icon placed on "LEFT SIDE"

### 35 Gallon Unit Key:

- REF 1: Icon placed on "FRONT"
- REF 2: Icon placed on "FRONT RIGHT SIDE"
- REF 3: Icon placed on "REAR RIGHT" (same side as hinged top)
- REF 4: Icon placed on "REAR LEFT SIDE"
- REF 5: Icon placed on "FRONT LEFT SIDE" (35 gal. only)

**Order Example: VA1818L / Dark Anthracite Body / Anodized Silver Top / Waste opening / Waste icon / Ref 1**

VALUTA units can be configured with our SOTARE family of receptacles.

# SOTARE™

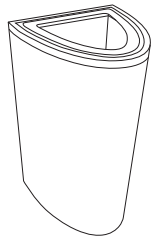

SO1818L

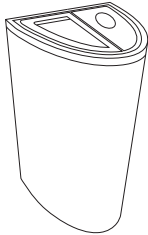

SO1818L-DBL

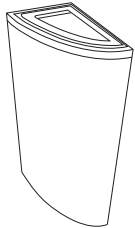

SO1809L-LEFT

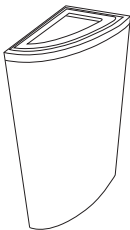

SO1809L-RIGHT

MODEL	H	W	D	SHIPPING WEIGHT	DESCRIPTION	COLOR/ FINISH	LIST PRICE
SO1818L	33 3/4"	18"	18"	49 lbs.†	Half elliptical shaped waste receptacle with internal rigid liner and removable wire bag ring. Single top opening. Includes two standard icons and adjustable glides. Capacity 34 gallons.	Dark Anthracite Anodized Silver Lunar White Bronze Metallic	\$1,475.00
SO1818L-DBL	33 3/4"	18"	18"	49 lbs.†	Half elliptical shaped waste receptacle with internal rigid liner and removable wire bag rings. Double top opening. Includes two standard icons and adjustable glides. Capacity 34 gallons.	Dark Anthracite Anodized Silver Lunar White Bronze Metallic	\$1,575.00
SO1809L-LEFT	33 3/4"	9"	18"	37 lbs.†	Left side quarter elliptical shaped waste receptacle with internal rigid liner and removable wire bag ring. Includes one standard icon and adjustable glides. Capacity 14 gallons.	Dark Anthracite Anodized Silver Lunar White Bronze Metallic	\$1,175.00
SO1809L-RIGHT	33 3/4"	9"	18"	37 lbs.†	Right side quarter elliptical shaped waste basket with internal rigid liner and removable wire bag ring. Includes one standard icon and adjustable glides. Capacity 14 gallons.	Dark Anthracite Anodized Silver Lunar White Bronze Metallic	\$1,175.00

**SOTARE** is available with the following top configurations as pictured below:

## Half-Elliptical Unit Top Configuration Options

SO1818L

SO1818L-DBL



Waste Opening  
12 1/8" x 11 3/4"

Circle Opening  
4 1/4" diameter

Paper Opening  
1 1/2" x 11 3/4"



Circle/Circle  
4 1/4" diameter

Circle/Waste  
4 1/4" diameter  
4 3/8" x 11 3/4"

Paper / Circle  
1 1/2" x 11 3/4"  
4 1/4" diameter

Waste / Waste  
4 3/8" x 11 3/4"

Paper / Waste  
1 1/2" x 11 3/4"  
4 3/8" x 11 3/4"

## Quarter-Elliptical Unit Top Configuration Options

SO1809L-LEFT

SO1809L-RIGHT



Waste Opening  
4 3/8" x 11 3/4"



Circle Opening  
4 1/4" diameter



Paper Opening  
1 1/2" x 11 3/4"

†Ships via common carrier

SOTARE bodies and tops are each available in the following powder coat paint colors



Dark Anthracite

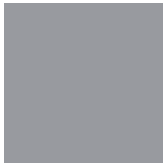

Anodized Silver



Lunar White



Bronze Metallic

**Note:** Colors are approximations and may appear different on your computer screen and in print. Sample paint chips available.

SOTARE is available with eight optional icon/references for easy sorting and disposal of various types of waste as follows:



**\*Dark Anthracite, Anodized Silver and Bronze Metallic body colors come standard with a White Icon / Reference label; Lunar White body color is standard with a Dark Gray Icon / Reference label. Sotare icons in each of the above references are also available in the following colors for a \$22.00 up charge per icon. Specify icon reference and color on order. ( ie. - recycling arrows in Olympic Blue )**



### How to order Sotare

When ordering Sotare, a selection must be made from each column below and noted on the order [see example below]

Sotare Model	Selection #1 Body Color Choice*	Selection #2 Top Color Choice	Selection #3 Top Configuration Choice	Selection #4 Icon / Reference Choice
SO1818L	Dark Anthracite, Anodized Silver, Bronze Metallic, Lunar White	Dark Anthracite, Anodized Silver, Bronze Metallic, Lunar White	Waste, Paper, Circle	Waste, Paper, Recycling, Cans, Plastic, Glass, Organics, Recycling Arrows
SO1809L-LEFT	Dark Anthracite, Anodized Silver, Bronze Metallic, Lunar White	Dark Anthracite, Anodized Silver, Bronze Metallic, Lunar White	Waste, Paper, Circle	Waste, Paper, Recycling, Cans, Plastic, Glass, Organics, Recycling Arrows
SO1809L-RIGHT	Dark Anthracite, Anodized Silver, Bronze Metallic, Lunar White	Dark Anthracite, Anodized Silver, Bronze Metallic, Lunar White	Waste, Paper, Circle	Waste, Paper, Recycling, Cans, Plastic, Glass, Organics, Recycling Arrows
SO1818L-DBL	Dark Anthracite, Anodized Silver, Bronze Metallic, Lunar White	Dark Anthracite, Anodized Silver, Bronze Metallic, Lunar White	Waste/Waste, Waste/Paper, Waste/Circle, Circle/Circle, Paper/Circle	Waste, Paper, Recycling, Cans, Plastic, Glass, Organics, Recycling Arrows (select 2)

SOTARE half elliptical units receive two icons per unit. SOTARE quarter elliptical units receive one icon per unit.

SOTARE units can also be configured with our Valuta family of receptacles.

# SLOPE™

MODEL	H	W	D	SHIPPING WEIGHT	DESCRIPTION	COLOR/ FINISH	LIST PRICE
SLP-01	38"	16 7/8"	18 1/8"	35 lbs†	38 gallon waste bin with single top opening, integrated bag arms and non-skid glides.	Body in Anodized Silver, Dark Anthracite or Lunar White. Top in Anodized Silver, Dark Anthracite, Lunar White, Capri Blue, Copper Brown, Fern Green or vinyl wrap*.	\$630.00
						Body in Anodized Silver, Dark Anthracite or Lunar White. Top in Polished Stainless Steel	\$695.00
						Body in Brushed Stainless Steel. Top in Anodized Silver, Dark Anthracite, Lunar White, Capri Blue, Copper Brown, Fern Green or vinyl wrap*.	\$825.00
						Body in Brushed Stainless Steel. Top in Polished Stainless Steel	\$895.00

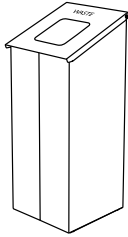

SLP-01

\*For 3M™ DI-NOC™ vinyl wrap lid, add \$150.00 to list price and select vinyl color:

- Weathered Wengue – DI-NOC™ # WG-696
- Weathered Walnut – DI-NOC™ # FW-1022
- White Washed Teak – DI-NOC™ # WG-960

SLP-01L	38"	16 7/8"	18 1/8"	43 lbs†	38 gallon waste bin with single top opening, internal rigid liner, integrated bag arms and non-skid glides.	Body in Anodized Silver, Dark Anthracite or Lunar White. Top in Anodized Silver, Dark Anthracite, Lunar White, Capri Blue, Copper Brown, Fern Green or vinyl wrap*.	\$720.00
						Body in Anodized Silver, Dark Anthracite or Lunar White. Top in Polished Stainless Steel.	\$795.00
						Body in Brushed Stainless Steel. Top in Anodized Silver, Dark Anthracite, Lunar White, Capri Blue, Copper Brown, Fern Green or vinyl wrap*.	\$915.00
						Body in Brushed Stainless Steel. Top in Polished Stainless Steel.	\$985.00

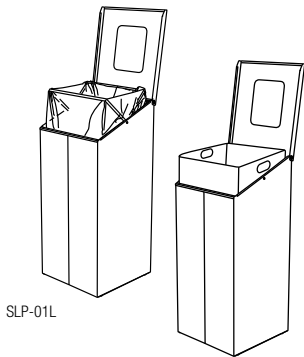

SLP-01L

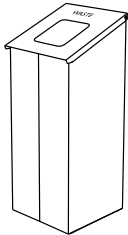

\*For 3M™ DI-NOC™ vinyl wrap lid, add \$150.00 to list price and select vinyl color:

- Weathered Wengue – DI-NOC™ # WG-696
- Weathered Walnut – DI-NOC™ # FW-1022
- White Washed Teak – DI-NOC™ # WG-960

†Ships via common carrier



# SLOPE™

MODEL	H	W	D	SHIPPING WEIGHT	DESCRIPTION	COLOR/ FINISH	LIST PRICE
-------	---	---	---	-----------------	-------------	------------------	------------

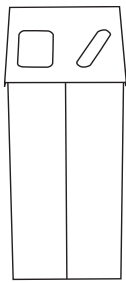

SLP-01L-DBL

SLP-01L-DBL	38"	16 7/8"	18 1/8"	43 lbs†	38 gallon waste bin with double top opening. Internal rigid liners, integrated bag arms and non-skid glides	Body in Anodized Silver, Dark Anthracite or Lunar White. Top in Anodized Silver, Dark Anthracite, Lunar White, Capri Blue, Copper Brown, Fern Green or vinyl wrap*.	\$965.00
						Body in Anodized Silver, Dark Anthracite or Lunar White. Top in Polished Stainless Steel.	\$1,045.00
						Body in Brushed Stainless Steel. Top in Anodized Silver, Dark Anthracite, Lunar White, Capri Blue, Copper Brown, Fern Green or vinyl wrap*.	\$1,165.00

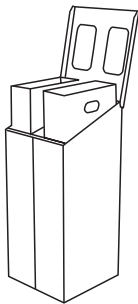

SLP-01L-DBL

\*For 3M™ DI-NOC™ vinyl wrap lid, add \$190.00 to list price and select vinyl color:

Weathered Wengue – DI-NOC™ # WG-696  
 Weathered Walnut – DI-NOC™ # FW-1022  
 White Washed Teak – DI-NOC™ #WG-960

SLP-GLD					Optional adjustable glides (must be ordered at same time as unit).	Black	\$50.00
---------	--	--	--	--	--	-------	---------

## SLOPE TOP OPENINGS:



Waste  
8" H x 9" W



Paper  
2" H x 12" W



Recycling  
9" H  
x 4 1/4" W



Waste / Waste  
9 1/16" H x 5" W /  
9 1/16" H x 5" W



Waste / Recycling  
9 1/16" H x 5" W /  
9 1/16" H x 4 1/2" W



Waste / Paper  
9 1/16" H x 5" W /  
9 1/16" H x 2" W



Recycling / Recycling  
9 1/16" H x 4 1/2" W  
9 1/16" H x 4 1/2" W



Recycling / Paper  
9 1/16" H x 4 1/2" W /  
9 1/16" H x 2" W

## SLOPE Standard English Label Options:



SLOPE bodies are each available in the following three standard powder coat paint colors and Brushed Stainless Steel:



Dark  
Anthracite



Anodized  
Silver



Lunar  
White



Brushed  
Stainless

†Ships via common carrier

SLOPE tops are each available in the following six standard powder coat paint colors and Polished Stainless Steel:

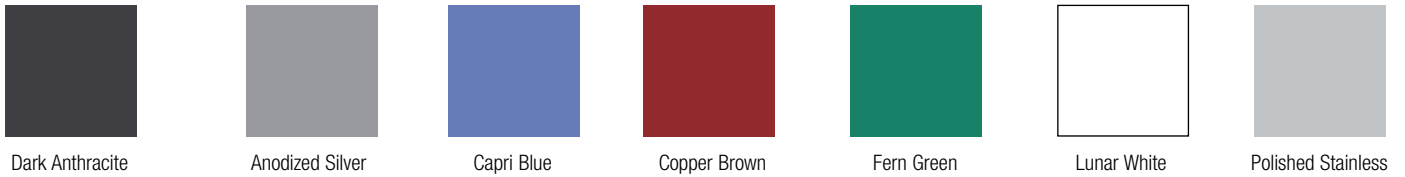

(Colors are approximations and may appear different on your computer screen or in print. Sample paint chips available.)  
 Note: Custom paint colors are available on SLOPE. Call customer service for details.

SLOPE tops are also available in the following three 3M™ DI-NOC™ vinyl wrap finishes (upcharge applies):



The orientation of the wood grain is vertical.

SLOPE is also available with the following (8) multi lingual pictogram labels instead of the standard English Labels\*:



All pictograms standard in white on all top colors except Lunar White which is supplied in Dark grey. Pictograms in each of the above references are also available in the following colors for a \$22.00 upcharge per icon. Specify icon reference and color on order. ( i.e., Paper icon in Cactus Green )

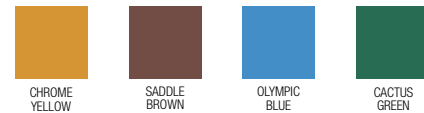

## How to order Slope

When ordering Slope, a selection must be made from each column below and noted on the order [see example below]

Slope Model	Selection #1 Body Color Choice	Selection #2 Top Color Choice	Selection #3 Top Opening Choice	Selection #4 Label Choice*
SLP-01/SLP-01L SLP-02/SLP-02L	Dark Anthracite Anodized Silver, Lunar White, Brushed Stainless Steel	Dark Anthracite, Anodized Silver, Lunar White, Capri Blue, Fern Green, Copper Brown, Polished Stainless Steel Vinyl Wrap*	Waste, Paper, Recycling	Waste, Paper, Recycling, Cans, Plastic, Glass, Organics
SLP-01L/DBL SLP-02L/DBL	Dark Anthracite Anodized Silver, Lunar White, Brushed Stainless Steel	Dark Anthracite, Anodized Silver, Lunar White, Capri Blue, Fern Green, Copper Brown, Polished Stainless Steel Vinyl Wrap*	Waste-Waste Waste-Recycling, Recycling-Recycling, Recycling-Paper, Waste-Paper	Waste, Paper, Recycling, Cans, Plastic, Glass, Organics (Select Two)

\* Specify on order if Multi Lingual pictogram is to be supplied in lieu of standard English label.

**Example:** SLP-01L DBL /Dark Anthracite Body/Capri Blue Top/Recycling /Recycling Opening, Cans Label on Left side, Plastic Label on right side. Single top opening units include one reference label, double top openings include two. References are placed on top of lid above top opening. Labels for double top units will be printed in slightly smaller font size.

\* Upcharge applies for 3M™ DI-NOC™ Vinyl Wrapped panels..

† Ships via common carrier

# SLOPE JUNIOR™

MODEL	H	W	D	SHIPPING WEIGHT	DESCRIPTION	COLOR/ FINISH	LIST PRICE
-------	---	---	---	-----------------	-------------	------------------	------------

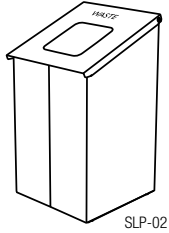

SLP-02	32"	16 7/8"	18 1/8"	32 lbs.†	32 gallon junior height waste bin with single top opening, integrated bag arms and non-skid glides.	Body in Anodized Silver, Dark Anthracite or Lunar White. Top in Anodized Silver, Dark Anthracite, Lunar White, Capri Blue, Copper Brown, Fern Green or vinyl wrap*.	\$575.00
--------	-----	---------	---------	----------	---	---	----------

Body in Anodized Silver, Dark Anthracite or Lunar White. Top in Polished Stainless Steel \$645.00

Body in Brushed Stainless Steel. Top in Anodized Silver, Dark Anthracite, Lunar White, Capri Blue, Copper Brown, Fern Green or vinyl wrap\*. \$755.00

Body in Brushed Stainless Steel. Top in Polished Stainless Steel \$825.00

\*For 3M™ DI-NOC™ vinyl wrap lid, add \$150.00 to list price and select vinyl color:

Weathered Wengue – DI-NOC™ # WG-696  
 Weathered Walnut – DI-NOC™ # FW-1022  
 White Washed Teak – DI-NOC™ #WG-960

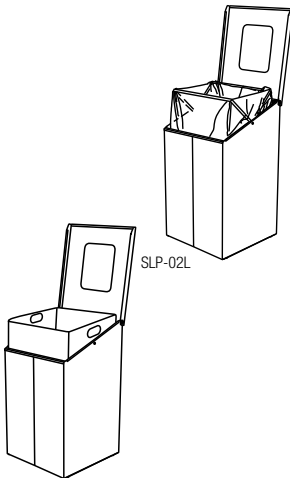

SLP-02L	32"	16 7/8"	18 1/8"	40 lbs.†	32 gallon junior height waste bin with single top opening, internal rigid liner, integrated bag arms and non-skid glides.	Body in Anodized Silver, Dark Anthracite or Lunar White. Top in Anodized Silver, Dark Anthracite, Lunar White, Capri Blue, Copper Brown, Fern Green or vinyl wrap*.	\$665.00
---------	-----	---------	---------	----------	---	---	----------

Body in Anodized Silver, Dark Anthracite or Lunar White. Top in Polished Stainless Steel \$745.00

Body in Brushed Stainless Steel. Top in Anodized Silver, Dark Anthracite, Lunar White, Capri Blue, Copper Brown, Fern Green or vinyl wrap\*. \$855.00

Body in Brushed Stainless Steel. Top in Polished Stainless Steel \$925.00

\*For 3M™ DI-NOC™ vinyl wrap lid, add \$150.00 to list price and select vinyl color:

Weathered Wengue – DI-NOC™ # WG-696  
 Weathered Walnut – DI-NOC™ # FW-1022  
 White Washed Teak – DI-NOC™ #WG-960

†Ships via common carrier

# SLOPE JUNIOR™

MODEL	H	W	D	SHIPPING WEIGHT	DESCRIPTION	COLOR/FINISH	LIST PRICE
SLP-02L-DBL	32"	16 7/8"	18 1/8"	40 lbs†	32 gallon junior height waste bin with double top opening. Internal rigid liners, integrated bag arms and non-skid glides	Body in Anodized Silver, Dark Anthracite or Lunar White. Top in Anodized Silver, Dark Anthracite, Lunar White, Capri Blue, Copper Brown, Fern Green or vinyl wrap*.	\$940.00
						Body in Anodized Silver, Dark Anthracite or Lunar White. Top in Polished Stainless Steel	\$1,025.00
						Body in Brushed Stainless Steel. Top in Anodized Silver, Dark Anthracite, Lunar White, Capri Blue, Copper Brown, Fern Green or vinyl wrap*.	\$1,135.00
						Body in Brushed Stainless Steel. Top in Polished Stainless Steel.	\$1,195.00

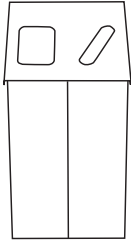

SLP-02L-DBL

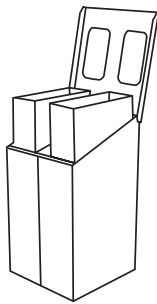

SLP-02L-DBL

\*For 3M™ DI-NOC™ vinyl wrap lid, add \$190.00 to list price and select vinyl color:

- Weathered Wengue – DI-NOC™ # WG-696
- Weathered Walnut – DI-NOC™ # FW-1022
- White Washed Teak – DI-NOC™ #WG-960

SLP-GLD					Optional adjustable glides (must be ordered at same time as unit).	Black	\$50.00
---------	--	--	--	--	--	-------	---------

† Ships via common carrier

## SLOPE Top Opening Options:



Waste  
8" H x 9" W



Paper  
2" H x 12" W



Recycling  
9" H x 4 1/4" W



Waste / Waste  
9 1/16" H x 5" W /  
9 1/16" H x 5" W



Waste / Recycling  
9 1/16" H x 5" W /  
9 1/16" H x 4 1/2" W



Waste / Paper  
9 1/16" H x 5" W /  
9 1/16" H x 2" W



Recycling / Recycling  
9 1/16" H x 4 1/2" W /  
9 1/16" H x 4 1/2" W



Recycling / Paper  
9 1/16" H x 4 1/2" W /  
9 1/16" H x 2" W

## SLOPE Standard English Label Options:



SLOPE bodies are each available in the following three standard powder coat paint colors and Brushed Stainless Steel:



Dark Anthracite



Anodized Silver



Lunar White



Brushed Stainless

# SLOPE JUNIOR™

SLOPE tops are each available in the following six standard powder coat paint colors and Polished Stainless Steel:

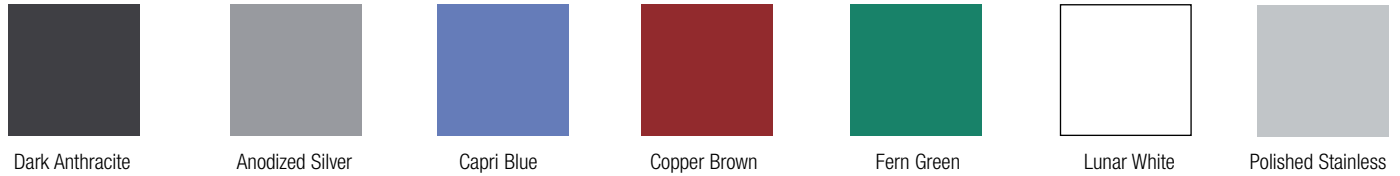

(Colors are approximations and may appear different on your computer screen or in print. Sample paint chips available.)  
 Note: Custom paint colors are available on SLOPE. Call customer service for details.

SLOPE tops are also available in the following three 3M™ DI-NOC™ vinyl wrap finishes (upcharge applies):



The orientation of the wood grain is vertical.

SLOPE is also available with the following (8) multi lingual pictogram labels instead of the standard English Labels\*:



All pictograms standard in white on all top colors except Lunar White which is supplied in Dark Grey. Pictograms in each of the above references are also available in the following colors for a \$22.00 upcharge per icon. Specify icon reference and color on order. ( i.e. Paper icon in Cactus Green )

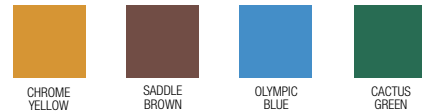

## How to order Slope

When ordering Slope, a selection must be made from each column below and noted on the order [see example below]

Slope Model	Selection #1 Body Color Choice	Selection #2 Top Color Choice	Selection #3 Top Opening Choice	Selection #4 Label Choice*
SLP-01/SLP-01L SLP-02/SLP-02L	Dark Anthracite Anodized Silver, Lunar White, Brushed Stainless Steel	Dark Anthracite, Anodized Silver, Lunar White, Capri Blue, Fern Green, Copper Brown, Polished Stainless Steel, Vinyl Wrap*	Waste, Paper, Recycling	Waste, Paper, Recycling, Cans, Plastic, Glass, Organics
SLP-01L/DBL SLP-02L/DBL	Dark Anthracite Anodized Silver, Lunar White, Brushed Stainless Steel	Dark Anthracite, Anodized Silver, Lunar White, Capri Blue, Fern Green, Copper Brown, Polished Stainless Steel, Vinyl Wrap*	Waste-Waste Waste-Recycling, Recycling-Recycling, Recycling-Paper, Waste-Paper	Waste, Paper, Recycling, Cans, Plastic, Glass, Organics, (Select two)

\* Specify on order if Multi Lingual pictogram is to be supplied in lieu of standard English label.

**Example:** SLP-01L-DBL/Dark Anthracite Body/Capri Blue Top/Recycling/Recycling Opening, Cans Label on Left side, Plastic Label on right side. Single top opening units include one reference label, double top openings include two. References are placed on top of lid above top opening. Labels for double top units will be printed in slightly smaller font size.

\* Upcharge applies for 3M™ DI-NOC™ Vinyl Wrapped panels.

# STORLEK™

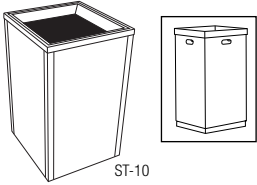
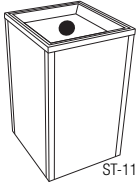
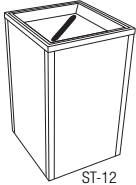
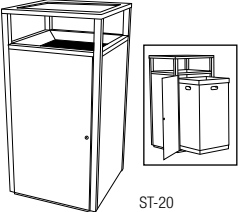
	MODEL	H	W	D	SHIPPING WEIGHT	DESCRIPTION	COLOR/ FINISH	LIST PRICE
	ST-10	39 1/2"	23 7/8"	23 7/8"	94 lbs.†	70 gallon waste bin with waste top and liner-front opening door with lock. One reference icon included.	Panels in Dark Anthracite, Anodized Silver, Lunar White Bronze Metallic or Vinyl Wrap*. Corners (Frame), top & base in Dark Anthracite, Anodized Silver, Lunar White, Bronze Metallic	\$1,575.00
						(Waste opening is 14 3/4")		
	ST-11	39 1/2"	23 7/8"	23 7/8"	94 lbs.†	70 gallon waste bin with recycling top and liner-front opening door with lock. One reference icon included.	Panels in Dark Anthracite, Anodized Silver, Lunar White Bronze Metallic or Vinyl Wrap*. Corners (Frame), top & base in Dark Anthracite, Anodized Silver, Lunar White, Bronze Metallic	\$1,575.00
						(circle opening is 8" diameter)		
	ST-12	39 1/2"	23 7/8"	23 7/8"	94 lbs.†	70 gallon waste bin with paper top and liner-front opening door with lock. One reference icon included.	Panels in Dark Anthracite, Anodized Silver, Lunar White Bronze Metallic or Vinyl Wrap*. Corners (Frame), top & base in Dark Anthracite, Anodized Silver, Lunar White, Bronze Metallic	\$1,575.00
						(paper opening is 2"w x 18"L)		
	*For 3M™ DI-NOC™ vinyl wrap lid, add \$995.00 to list price and select vinyl color:							
	Weathered Wengue – DI-NOC™ # WG-696							
	Weathered Walnut – DI-NOC™ # FW-1022							
	White Washed Teak – DI-NOC™ #WG-960							
	ST-20	48"	23 7/8"	23 7/8"	106 lbs.†	70 gallon waste bin with traytop and liner –front opening door with lock. (fits most standard food service trays). One reference icon included.	Panels in Dark Anthracite, Anodized Silver, Lunar White Bronze Metallic or Vinyl Wrap*. Corners (Frame), top & base in Dark Anthracite, Anodized Silver, Lunar White, Bronze Metallic	\$1,875.00
	*For 3M™ DI-NOC™ vinyl wrap lid, add \$995.00 to list price and select vinyl color:							
	Weathered Wengue – DI-NOC™ # WG-696							
	Weathered Walnut – DI-NOC™ # FW-1022							
	White Washed Teak – DI-NOC™ #WG-960							

STORLEK trim/top and side panels are each available in the following (4) standard powder-coat paint colors:



Dark Anthracite



Anodized Silver



Lunar White



Bronze Metallic

**Note:** Colors are approximations and may appear different on your computer screen and in print. Sample paint chips available.  
Note: Custom paint colors are available on STORLEK,. Call customer service for details.

† Ships via common carrier

# STORLEK™

STORLEK side panels and door are also available in 3M™ DI-NOC™ vinyl wrap\* in the following colors. Upcharge applies.



Weathered Walnut  
DI-NOC™ # FW-1022



White Washed Teak  
DI-NOC™ # WG-960



Weathered Wengue  
DI-NOC™ # WG-696

## STORLEK Multi-Lingual Pictogram Labels

Storlek is available with the following (8) multi-lingual pictogram labels



Storlek icons in each of the above references are also available in the following colors for a \$34.00 up charge per icon. Specify icon reference and color on order. (i.e. Glass Icon in Cactus Green)



## How To Order / Specify STORLEK

When ordering STORLEK, a selection must be made from each column below and noted on the order [see example below]

STORLEK Model	Selection #1 Trim/Top Color Choice	Selection #2 Side Panels Color Choice	Selection #3 Selected Reference Icon	Selection #4 Reference Icon Placement
ST-10 ST-11, ST-12 ST-20	Dark Anthracite, Anodized Silver, Bronze Metallic, Lunar White	Dark Anthracite, Anodized Silver, Bronze Metallic, Lunar White OR Vinyl Wrap*	Waste, Paper, Recycling, Cans, Plastic, Glass, Organics, Recycling Arrows	Ref. 1 – Front Door Ref. 2 – Right Side Ref. 3 – Rear Ref. 4 – Left side

### Order Example:

ST-10 /

Anodized Silver trim & top /  
Dark Anthracite side panels /  
waste Icon / Ref 1

REF 1: Icon placed on Front Door

REF 2: Icon placed on "RIGHT SIDE"

REF 3: Icon placed on "REAR"









REF 4: Icon placed on "LEFT SIDE"



All Storlek models include lock and two keys. Lock is located on right side of door, hinge on left. Advise on order if lock is to be located on left, hinge on right.

\* Upcharge applies for 3M™ DI-NOC™ Vinyl Wrapped panels.







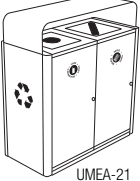

# UMEA

MODEL	H	W	D	SHIPPING WEIGHT	DESCRIPTION	COLOR/ FINISH	LIST PRICE
  UMEA-10	35 1/2"	22"	18 1/2"	72 lbs.†	Single 40 gallon compartment waste receptacle with internal rigid liner and locking front opening. Single top opening with painted or vinyl wrap* side panels.	Body colors in Sky White, Britebond Silver or Mineral Bronze. Side panels/hood colors in Sky White, Britebond Silver, Mineral Bronze, Sea Green, Marigold Yellow, Marine Blue, Clementine Orange or vinyl wrap*. Top insert colors in Sea Green, Marigold Yellow, Marine Blue, Clementine Orange, Sky White, Britebond Silver or Mineral Bronze.	\$1,695.00
*For 3M™ DI-NOC™ vinyl wrapped side panels, add \$300.00 to list price and select vinyl color: Weathered Wengue – DI-NOC™ # WG-696 Weathered Walnut – DI-NOC™ # FW-1022 White Washed Teak – DI-NOC™ #WG-960							
  UMEA-11	44 3/4"	22"	18 1/2"	96 lbs.†	Same as Umea 10 but with flat hood.	Same as above.	Add \$315.00
*For 3M™ DI-NOC™ vinyl wrapped flat hood and side panels, add \$495.00 to list price and select vinyl color: Weathered Wengue – DI-NOC™ # WG-696 Weathered Walnut – DI-NOC™ # FW-1022 White Washed Teak – DI-NOC™ #WG-960							
  UMEA-12	46 3/4"	22"	18 1/2"	101 lbs.†	Same as Umea 10 but with angled hood.	Same as above.	Add \$395.00
*For 3M™ DI-NOC™ vinyl wrapped angled hood and side panels, add \$600.00 to list price and select vinyl color: Weathered Wengue – DI-NOC™ # WG-696 Weathered Walnut – DI-NOC™ # FW-1022 White Washed Teak – DI-NOC™ #WG-960							
  UMEA-20	35 1/2"	40"	18 1/2"	140 lbs.†	Double 40 gallon compartment waste receptacle with two internal rigid liners and two locking front openings. Two top openings with painted or vinyl wrap* side panels.	Body colors in Sky White, Britebond Silver or Mineral Bronze. Side panels/hood colors in Sky White, Britebond Silver, Mineral Bronze, Sea Green, Marigold Yellow, Marine Blue, Clementine Orange or vinyl wrap*. Top insert colors in Sea Green, Marigold Yellow, Marine Blue, Clementine Orange, Sky White, Britebond Silver or Mineral Bronze.	\$2,695.00
*For 3M™ DI-NOC™ vinyl wrapped side panels, add \$300.00 to list price and select vinyl color: Weathered Wengue – DI-NOC™ # WG-696 Weathered Walnut – DI-NOC™ # FW-1022 White Washed Teak – DI-NOC™ #WG-960							

† Ships via common carrier

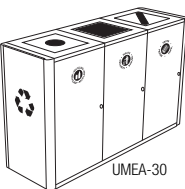

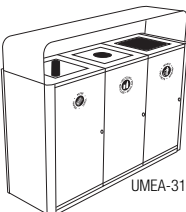
# UMEA

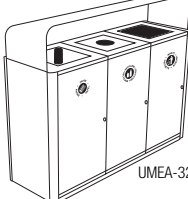
	MODEL	H	W	D	SHIPPING WEIGHT	DESCRIPTION	COLOR/ FINISH	LIST PRICE
  UMEA-21	UMEA-21	44 3/4"	40"	18 1/2"	164 lbs.†	Same as Umea 20 but with flat hood.	Same as above.	Add \$395.00
						*For 3M™ DI-NOC™ vinyl wrapped flat hood and side panels, add \$550.00 to list price and select vinyl color: Weathered Wengue – DI-NOC™ # WG-696 Weathered Walnut – DI-NOC™ # FW-1022 White Washed Teak – DI-NOC™ #WG-960		
  UMEA-22	UMEA-22	46 3/4"	40"	18 1/2"	169 lbs.†	Same as Umea 20 but with angled hood.	Same as above.	Add \$475.00
						*For 3M™ DI-NOC™ vinyl wrapped angled hood and side panels, add \$735.00 to list price and select vinyl color: Weathered Wengue – DI-NOC™ # WG-696 Weathered Walnut – DI-NOC™ # FW-1022 White Washed Teak – DI-NOC™ #WG-960		
  UMEA-30	UMEA-30	35 1/2"	58"	18 1/2"	203 lbs.†	Triple 40 gallon compartment waste receptacle with three internal rigid liners and three locking front openings. Three top openings with painted or vinyl wrap side panels.	Body colors in Sky White, Britebond Silver or Mineral Bronze. Side panels/hood colors in Sky White, Britebond Silver, Mineral Bronze, Sea Green, Marigold Yellow, Marine Blue, Clementine Orange or vinyl wrap*. Top insert colors in Yellow, Marine Blue, Clementine Orange, Sky White, Britebond Silver or Mineral Bronze.	\$3,795.00
						*For 3M™ DI-NOC™ vinyl wrapped side panels, add \$300.00 to list price and select vinyl color: Weathered Wengue – DI-NOC™ # WG-696 Weathered Walnut – DI-NOC™ # FW-1022 White Washed Teak – DI-NOC™ #WG-960		
  UMEA-31	UMEA-31	44 3/4"	58"	18 1/2"	227 lbs.†	Same as Umea 30 but with flat hood.	Same as above.	Add \$445.00
						*For 3M™ DI-NOC™ vinyl wrapped flat hood and side panels, add \$645.00 to list price and select vinyl color: Weathered Wengue – DI-NOC™ # WG-696 Weathered Walnut – DI-NOC™ # FW-1022 White Washed Teak – DI-NOC™ #WG-960		
  UMEA-32	UMEA-32	46 3/4"	58"	18 1/2"	232 lbs.†	Same as Umea 30 but with angled hood.	Same as above.	Add \$525.00
						*For 3M™ DI-NOC™ vinyl wrapped angled hood and side panels, add \$895.00 to list price and select vinyl color: Weathered Wengue – DI-NOC™ # WG-696 Weathered Walnut – DI-NOC™ # FW-1022 White Washed Teak – DI-NOC™ #WG-960		

UMEA 11, 21, and 31 flat hood units can be provided with a black non-slip traytop pad for foodservice trays an upcharge of \$ 30 list per top opening positions.

† Ships via common carrier

Vinyl wrap not recommended for outdoor use. Some line art shown with optional side panel cutouts.

UMEA is available with three top opening options.



UMEA Bodies are each available in the following powder coat paint colors.



UMEA Top Inserts, Side Panels and Flat or Angled Hoods are available in the following powder coat paint colors.



**Note:** Colors are approximations and may appear different on your computer screen and in print. Sample chips available.

UMEA side panels and flat or angled hoods are also available in the following 3M™ DI-NOCT™ vinyl wrap colors. (Upcharge applies).



**Note:** Colors are approximations and may appear different on your computer screen and in print. Sample chips available. The orientation of the wood grain is vertical. We cannot guarantee a grain match when crossing the seam from panel to top hood.

UMEA is also available with seven optional icon/references for easy sorting and disposal of various types of waste as follows.



## HOW TO ORDER UMEA

When ordering Umea, a selection must be made from each column below and noted on the order (see example below)

Umea Model	Selection #1 Body Color Choice	Selection #2 Top Insert Choice	Selection #3 Top Insert Color Choice	Selection #4 Side Panel/Hood Color Choice	Selection #5 Icon Choice	Selection #6 Icon Color Choice
Umea-10 Umea-11 Umea-12 Single Compartment Unit	Sky White, Britebond Silver, Mineral Bronze	Waste Circle, Paper	Sea Green, Sky White, Britebond Silver, Mineral Bronze, Marigold Yellow, Marine Blue, Clementine Orange	Sea Green, Sky White, Britebond Silver, Mineral Bronze, Marigold Yellow, Marine Blue, Clementine Orange Vinyl Wrap	Waste, Recycling Arrows, Paper, Cans, Plastic, Glass, Organics	White, Dark Gray, Green, Blue, Yellow or Orange
Umea-20 Umea-21 Umea-22 Two Compartment Unit	Sky White, Britebond Silver, Mineral Bronze	Waste Circle, Paper (Choose 2)	Sea Green, Sky White, Britebond Silver, Mineral Bronze, Marigold Yellow, Marine Blue, Clementine Orange (Choose 2)	Sea Green, Sky White, Britebond Silver, Mineral Bronze, Marigold Yellow, Marine Blue, Clementine Orange Vinyl Wrap	Waste, Recycling Arrows, Paper, Cans, Plastic, Glass, Organics (Choose 2)	White, Dark Gray, Green, Blue, Yellow or Orange (Choose 2)
Umea-30 Umea-31 Umea-32 Three Compartment Unit	Sky White, Britebond Silver, Mineral Bronze	Waste Circle, Paper (Choose 3)	Sea Green, Sky White, Britebond Silver, Mineral Bronze, Marigold Yellow, Marine Blue, Clementine Orange (Choose 3)	Sea Green, Sky White, Britebond Silver, Mineral Bronze, Marigold Yellow, Marine Blue, Clementine Orange Vinyl Wrap	Waste, Recycling Arrows, Paper, Cans, Plastic, Glass, Organics (Choose 3)	White, Dark Gray, Green, Blue, Yellow or Orange (Choose 3)

**Note:** For two compartment and three compartment Umea units, please specify top insert and colors for each compartment as units are shipped assembled. Example – for Umea 30 – compartment 1 – waste insert in Clementine Orange, compartment 2 circle insert in Marine Blue, compartment 3 – paper insert in Sea Green.

### Optional Side Panel Cutouts

Umea is available with optional side panel cutouts for an additional list price of \$195.00. Select one only – cutout will be on both side panels.

1. Waste cutout
2. Recycling Arrows cutout
3. Geometric Pattern cutout



WASTE



RECYCLING



GEOMETRIC  
PATTERN

Optional side panel cutouts can be vinyl wrapped with 3M™ DI-NOC™ vinyl wrap for an upcharge as follows:

Add \$195.00 list for special waste side panel cut out plus \$395.00 list for vinyl wrap and select color.

Add \$195.00 list for special recycling arrows side panel cut out plus \$395.00 list for vinyl wrap and select color.

Vinyl wrap not available on geometric pattern side panels.

Weathered Wengue – DI-NOC™ #WG-696

Weathered Walnut – DI-NOC™ #FW-1022

White Washed Teak – DI-NOC™ WG-960

Vinyl wrap not recommended for outdoor use.

### Order Example:

Umea-10/Sky White Body/Marine Blue side panels/Waste opening, Marine Blue/Waste graphic Marine Blue

Umea-21/Britebond Silver body/Sky White side panels & flat hood/Waste opening, Marine Blue; Recycling opening, Clementine Orange/Waste graphic, Marine Blue, Recycling graphic, Clementine Orange/Optional Waste cutout in side panels.

Umea-32/Mineral Bronze body/Sky White side panels and angled hood/Waste opening; Marine Blue; Recycling opening, Clementine Orange; Paper opening, Marigold Yellow/Waste graphic, Marine Blue; Recycling graphic, Clementine Orange; Paper graphic, Marigold Yellow/Optional Flat Hood, Sky White/Optional Geometric pattern cutout in side panels.

† Ships via common carrier

RIGA

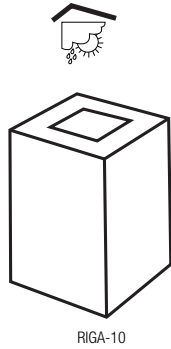

RIGA-10

MODEL	H	W	D	SHIPPING WEIGHT	DESCRIPTION	COLOR/ FINISH	LIST PRICE
RIGA-10	19 5/16"	9 13/16"	9 13/16"	11 lbs.	Stainless Steel waste receptacle with painted top. Integrated bag ring. Top lifts out to change bag. Capacity 5.3 gallons.	Stainless Steel body with painted top in Ral 9006 Aluminum, Blue Pantone P628U, Yellow, Green, Brown Pantone P408U or vinyl wrap*	\$575.00
RIGA-10P	19 5/16"	9 13/16"	9 13/16"	11 lbs.	Painted waste receptacle with integrated bag ring. Top lifts out to change bag. Capacity 5.3 gallons.	Grey White Ral 9002 painted body with painted top in Ral 9006 Aluminum, Blue Pantone P628U, Yellow, Green, Brown Pantone P408U or vinyl wrap*	\$415.00
For 3M™ DI-NOC™ vinyl wrap lid, add \$90.00 to list price and select vinyl color : Weathered Wengue – DI-NOC™ # WG-696 Weathered Walnut – DI-NOC™ # FW-1022 White Washed Teak – DI-NOC™ #WG-960  Top opening is 4 11/16" x 4 11/16"							

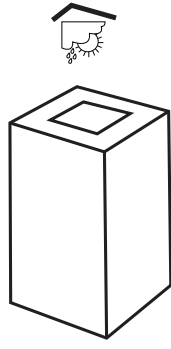

RIGA-20

RIGA-20	27 15/16"	9 13/16"	9 13/16"	15 lbs.	Stainless Steel waste receptacle with painted top. Integrated bag ring. Top lifts out to change bag. Capacity 7.9 gallons.	Stainless Steel body with painted top in Ral 9006 Aluminum, Blue Pantone P628U, Yellow, Green, Brown Pantone P408U or vinyl wrap*	\$720.00
RIGA-20P	27 15/16"	9 13/16"	9 13/16"	15 lbs.	Painted waste receptacle with integrated bag ring. Top lifts out to change bag. Capacity 7.9 gallons.	Grey White Ral 9002 painted body with painted top in Ral 9006 Aluminum, Blue Pantone P628U, Yellow, Green, Brown Pantone P408U or vinyl wrap*	\$445.00
For 3M™ DI-NOC™ vinyl wrap lid, add \$90.00 to list price and select vinyl color : Weathered Wengue – DI-NOC™ # WG-696 Weathered Walnut – DI-NOC™ # FE-1022 White Washed Teak – DI-NOC™ #WG-960  Top opening is 4 11/16" x 4 11/16"							

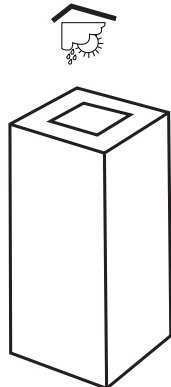

RIGA-30

RIGA-30	28 3/4"	12 3/16"	12 3/16"	19 lbs.†	Stainless Steel waste receptacle with painted top. Integrated bag ring. Top lifts out to change bag. Capacity 13.2 gallons.	Stainless Steel body with painted top in Ral 9006 Aluminum, Blue Pantone P628U, Yellow, Green, Brown Pantone P408U or vinyl wrap*	\$835.00
RIGA-30P	28 3/4"	12 3/16"	12 3/16"	19 lbs.†	Painted waste receptacle with integrated bag ring. Top lifts out to change bag. Capacity 13.2 gallons.	Grey White Ral 9002 painted body with painted top in Ral 9006 Aluminum, Blue Pantone P628U, Yellow, Green, Brown Pantone P408U or vinyl wrap*	\$520.00
*For 3M™ DI-NOC™ vinyl wrap lid, add \$95.00 to list price and select vinyl color: Weathered Wengue – DI-NOC™ # WG-696 Weathered Walnut – DI-NOC™ # FW-1022 White Washed Teak – DI-NOC™ #WG-960  Top opening is 6 7/8" x 6 7/8"							

†Ships via common carrier

## RIGA

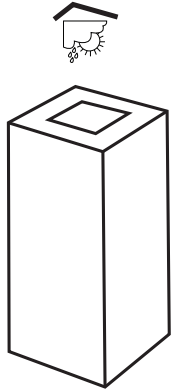

RIGA-40

MODEL	H	W	D	SHIPPING WEIGHT	DESCRIPTION	COLOR/ FINISH	LIST PRICE
RIGA-40	29 15/16"	13 3/4"	13 3/4"	22 lbs. †	Stainless Steel waste receptacle with painted top. Integrated bag ring. Top lifts out to change bag. Capacity 23.8 gallons.	Stainless Steel body with painted top in Ral 9006 Aluminum, Blue Pantone P628U, Yellow, Green, Brown Pantone P408U or vinyl wrap*	\$940.00
RIGA-40P	29 15/16"	13 3/4"	13 3/4"	22 lbs. †	Painted waste receptacle with integrated bag ring. Top lifts out to change bag. Capacity 23.8 gallons.	Grey White Ral 9002 painted body with painted top in Ral 9006 Aluminum, Blue Pantone P628U, Yellow, Green, Brown Pantone P408U or vinyl wrap*	\$595.00

\*For 3M™ DI-NOCT™ vinyl wrap lid, add \$110.00 to list price and select vinyl color:  
 Weathered Wengue – DI-NOCT™ # WG-696  
 Weathered Walnut – DI-NOCT™ # FW-1022  
 White Washed Teak – DI-NOCT™ #WG-960

Top opening is 6 7/8" x 6 7/8"

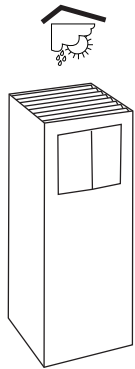

RIGA-ASH

RIGA-ASH	27 15/16"	9 13/16"	9 13/16"	15 lbs. †	Waste bin with front opening, integrated bag ring and ashtray. Capacity 7.9 gallons	Stainless Steel with Satin Silver Aluminum top.	\$720.00
RIGA-ASH-P	27 15/16"	9 13/16"	9 13/16"	15 lbs. †	Waste bin with front opening, integrated bag ring and ashtray. Capacity 7.9 gallons	Grey White Ral 9002 painted body with Satin Silver Aluminum top.	\$445.00

\*For 3M™ DI-NOCT™ vinyl wrap lid, add \$110.00 to list price and select vinyl color:  
 Weathered Wengue – DI-NOCT™ # WG-696  
 Weathered Walnut – DI-NOCT™ #FW-1022  
 White Washed Teak – DI-NOCT™ # WG-960

Riga Stainless Steel units are suitable for outdoor use under cover. Painted and units with vinyl wrap are for indoor use only. See page 123 for matching umbrella stand.



Weathered Walnut  
DI-NOCT™ # FW-1022



White Washed Teak  
DI-NOCT™ # WG-960



Weathered Wengue  
DI-NOCT™ # WG-696

**Note:** Colors are approximations and may appear different on your computer screen and in print. Sample chips available. The orientation of the wood grain is vertical.

†Ships via common carrier

# TRADA

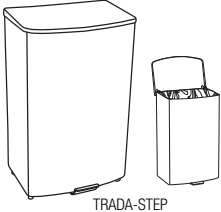
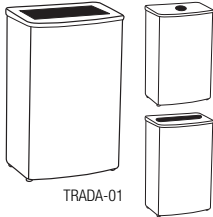
MODEL	H	W	D	SHIPPING WEIGHT	DESCRIPTION	COLOR/ FINISH	LIST PRICE
 TRADA-STEP	30"	18 5/16"	14 1/4"	53 lbs.†	24 gallon painted steel waste receptacle with step mechanism with soft close, internal liner and bag ring. Closed top, adjustable glides. One icon included. Liner capacity 16 gallons. Top and step are painted the same color	Body in Sky White, Britebond Silver or Mineral Bronze. Top in Sky White, Brite bond Silver, Mineral Bronze, Sea Green, Marigold Yellow, Marine Blue or Clementine Orange.	\$1,175.00
 TRADA-01	30"	18 5/16"	12 1/4"	50 lbs.†	24 gallon painted steel waste receptacle with three top opening options, internal liner and bag ring. adjustable glides. One icon included. Liner capacity 16 gallons.	Body in Sky White, Britebond Silver or Mineral Bronze. Top in Sky White, Brite bond Silver, Mineral Bronze, Sea Green, Marigold Yellow, Marine Blue or Clementine Orange.	\$895.00

TRADA-01 Tops are available with three top opening options



TRADA Bodies are each available in the following powder coat paint colors



TRADA Tops are available in the following powder coat paint colors



TRADA is available with 10 optional icon/references for easy sorting and disposal of various types of waste as follows:

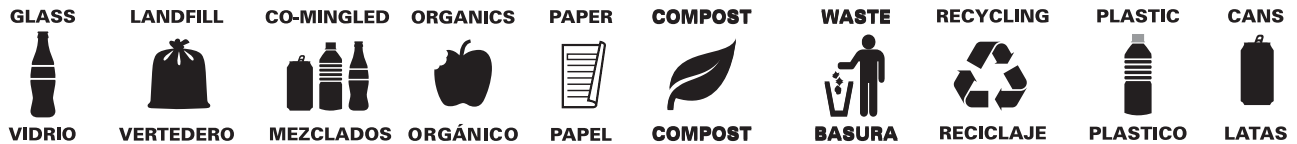

TRADA icons are available in White, Dark Grey, Chrome Yellow, Olympic Blue, Cactus Green or Orange

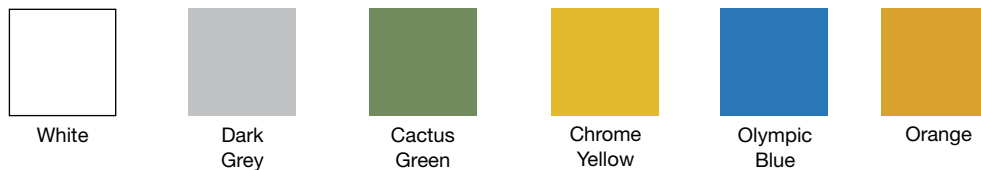

**Note:** Colors are approximations and may appear different on your computer screen and in print. Sample chips available.

To order Trada, a selection needs to be made from most / all of the above options.

**Example:** Trada-01, recycling opening, Sky White body color, Marine Blue top color, recycling icon in Olympic Blue.

†Ships via common carrier

PIC

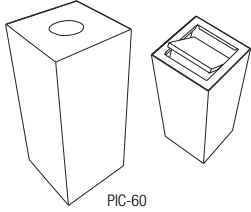
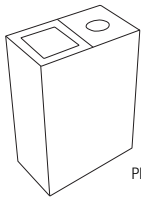
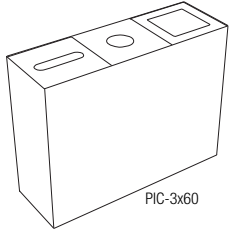
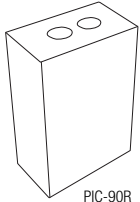
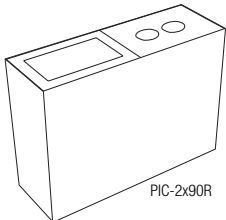
	MODEL	H	W	D	SHIPPING WEIGHT	DESCRIPTION	COLOR/ FINISH	LIST PRICE
 <p>PIC-60</p>	PIC-60	26 15/16"	11 7/8"	11 7/8"	15 lbs.†	Single compartment painted steel waste receptacle with bag ring and removable top with Waste, Paper, or Circle standard lid. Capacity 16 gallon. Includes one icon.	White or Silver body, top in Blue, Green, Red, Yellow, Chocolate, White or Silver	\$640.00
						For counterbalanced swing lid		Add \$170.00
 <p>PIC-2x60</p>	PIC-2x60	26 15/16"	23 5/8"	11 7/8"	31 lbs.†	Double compartment painted steel waste receptacle with bag rings and removable tops with Waste, Paper or Circle openings (choose 2). Total capacity 32 gallons. Includes two icons.	White or Silver body, top in Blue, Green, Red, Yellow, Chocolate, White or Silver	\$955.00
						For counterbalanced swing lid		Add \$170.00 each
 <p>PIC-3x60</p>	PIC-3x60	26 15/16"	35 5/16"	11 7/8"	50 lbs.†	Triple compartment painted steel waste receptacle with bag rings and removable tops with Waste, Paper or Circle openings (choose 3). Total capacity 48 gallons. Includes three icons.	White or Silver body, top in Blue, Green, Red, Yellow, Chocolate, White or Silver	\$1,460.00
						For counterbalanced swing lid		Add \$170.00 each
 <p>PIC-90R</p>	PIC-90R	26 15/16"	17 11/16"	11 7/8"	22 lbs.†	Single compartment painted steel waste receptacle with bag ring and removable top with Waste, Paper or double Circle opening. Capacity 24 gallons. Includes one icon.	White or Silver body, top in Blue, Green, Red, Yellow, Chocolate, White or Silver	\$695.00
						For counterbalanced swing lid		Add \$185.00 each
 <p>PIC-2x90R</p>	PIC-2x90R	26 15/16"	35 5/16"	11 7/8"	50 lbs.†	Double compartment painted steel waste receptacle with bag rings and removable tops with Waste, Paper or double Circle opening (choose two). Total capacity 48 gallons. Includes two icons.	White or Silver body, tops in Blue, Green, Red, Yellow, Chocolate, White or Silver	\$1,415.00
						For counterbalanced swing lid		Add \$185.00 each

†Ships via common carrier

## PIC

PIC is available with three standard top openings and a counterbalanced swing lid.

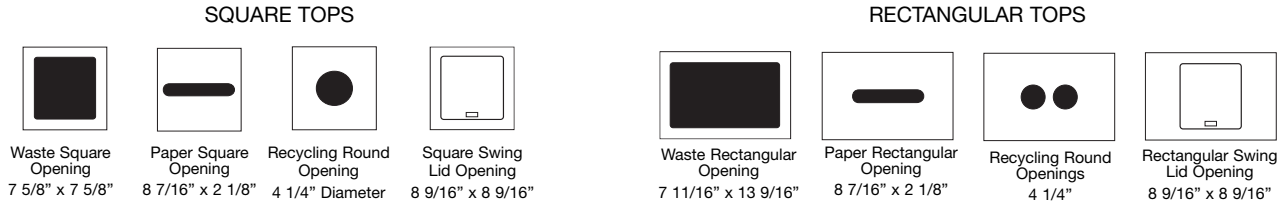

PIC Body is available in White or Silver



PIC Tops are available in Blue, Green, Red, Yellow, Chocolate, Silver or White

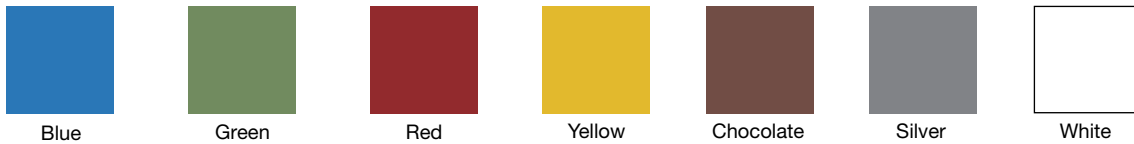

PIC is available with your choice of the following icons/references:  
(White bodies have Grey icons, Silver bodies have White icons)

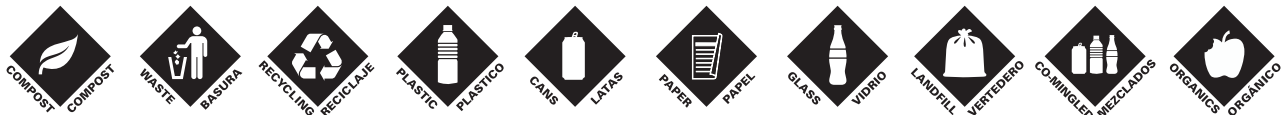

### HOW TO ORDER PIC

When ordering PIC, a selection must be made from each column below and noted on the order

PIC Model	Selection #1 Body Color Choice	Selection #2 Top Opening Choice	Selection #3 Top Opening Color Choice	Selection #4 Icon Choice
PIC-60 PIC-90R	White, Silver	Waste, Paper, Circle or Counterbalanced Swing lid	Blue, Green, Red, Yellow, Chocolate, Silver or White	Compost, Waste, Recycling, Plastic, Cans, Paper, Glass, Landfill, Co-Mingled or Organics
PIC-2x60 PIC-2x90R	White, Silver	Waste, Paper, Circle or Counterbalanced Swing lid (Choose 2)	Blue, Green, Red, Yellow, Chocolate, Silver or White (Choose 2)	Compost, Waste, Recycling, Plastic, Cans, Paper, Glass, Landfill, Co-Mingled or Organics (Choose 2)
PIC-3x60	White, Silver	Waste, Paper, Circle or Counterbalanced Swing lid (Choose 3)	Blue, Green, Red, Yellow, Chocolate, Silver or White (Choose 3)	Compost, Waste, Recycling, Plastic, Cans, Paper, Glass, Landfill, Co-Mingled or Organics (Choose 3)

**Order example:** PIC 2x60, White Body, Waste opening left in Chocolate, Circle opening right in Blue,  
Waste icon left, Recycling icon right.

**Note:** Colors are approximations and may appear different on your computer screen and in print. Sample chips available.



## STILO

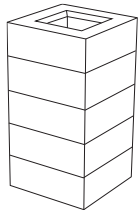

STILO-01

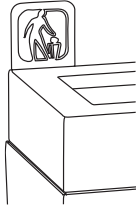

STILO-SIGN

MODEL	H	W	D	SHIPPING WEIGHT	DESCRIPTION	COLOR/ FINISH	LIST PRICE
-------	---	---	---	-----------------	-------------	---------------	------------

STILO-01	29 1/2"	15 3/8"	15 3/8"	27 lbs.†	Metal waste receptacle constructed of 100% recyclable steel. Removable lid with internal rigid liner. Capacity 26.4 gallons.	Anthracite or White body, lid in Grey, White, Green, Yellow or Blue.	\$995.00
----------	---------	---------	---------	----------	--	--	----------

Stilo can be supplied with seven optional icon/references for easy sorting and disposal of various types of waste as follows:



STILO-SIGN	5 1/8"	5 1/8"	1/16"	2 lbs.	Metal signage plate for use with Stilo waste receptacle	Grey, White, Green, Blue, or Yellow	\$30.00
------------	--------	--------	-------	--------	---	-------------------------------------	---------

See pg. 52 for matching planters.

## ZURICH

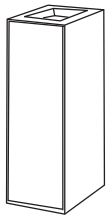

ZUR-01

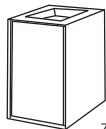

ZUR-02

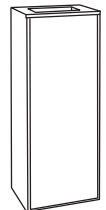

ZUR-03

MODEL	H	W	D	SHIPPING WEIGHT	DESCRIPTION	COLOR/ FINISH	LIST PRICE
-------	---	---	---	-----------------	-------------	---------------	------------

ZUR-01	27 15/16"	14 3/16"	9 7/16"	18 lbs.†	Metal waste receptacle with integrated bag arms. Black injection molded polycarbonate lid with square waste opening. Capacity 11.9 gallons.	Anthracite body, Grey front panel, Black polycarbonate lid.	\$775.00
ZUR-02	15 3/4"	13 3/4"	9 7/16"	12 lbs.	Metal waste receptacle with integrated bag arms. Black injection molded polycarbonate lid with square waste opening. Capacity 6.6 gallons.	Anthracite body, Grey front panel, Black polycarbonate lid.	\$485.00
ZUR-03	38 9/16"	11 7/16"	15 3/8"	45 lbs.†	Metal waste receptacle with integrated bag arms and Silver painted steel lid with square waste opening. Capacity 26.4 gallons.	Anthracite body, Grey front panel, Silver painted Steel lid.	\$1,095.00

Zurich Waste Receptacles can be supplied with eight optional icon / references for easy sorting and disposal of various types of waste as follows:



Waste



Paper



Recycling



Cans



Plastic



Glass



Organics



Recycling Arrows

†Ships via common carrier

## SORTMATE

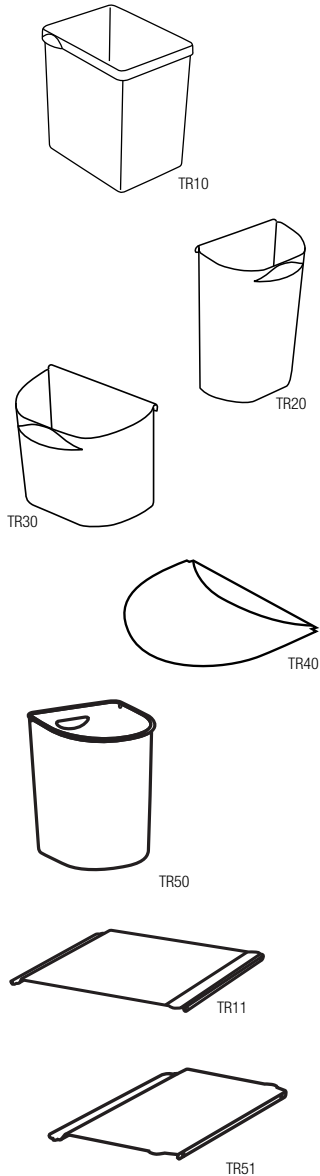

MODEL	H	W	D	SHIPPING WEIGHT	DESCRIPTION	COLOR/ FINISH	LIST PRICE
TR-10-REC	13 3/8"	13 1/16"	9 5/8"	5 lbs.	6.9 gallon main bin	Recycled Black polypropylene	\$65.00
TR-10-PP	13 3/8"	13 1/16"	9 5/8"	5 lbs.	6.9 gallon main bin	White or Silver polypropylene	\$97.00
TR-20-REC	13 5/8"	9 5/16"	6 13/16"	3 lbs.	2.4 gallon large side bin	Recycled Black polypropylene	\$45.00
TR-20-PP	13 5/8"	9 5/16"	6 13/16"	3 lbs.	2.4 gallon large side bin	White or Silver polypropylene	\$61.00
TR-30-REC	7 3/16"	9 5/16"	6 13/16"	1 lb.	1.3 gallon small side bin	Recycled Black polypropylene	\$29.00
TR-30-PP	7 3/16"	9 5/16"	6 13/16"	1 lb.	1.3 gallon small side bin	White or Silver polypropylene	\$41.00
TR-40	N/A	9 5/16"	6 13/16"	1/4 lb.	Lid for TR20 and TR30	White, Black, Blue, Red, Green, Yellow or Silver	\$20.00
TR-50-REC	13 5/8"	10 1/16"	10 3/16"	4 lbs.	4.75 gallon bin	Recycled Black polypropylene	\$47.00
TR-50-PP	13 5/8"	10 1/16"	10 3/16"	4 lbs.	4.75 gallon bin	White or Silver polypropylene	\$95.00
TR-51	N/A	6 3/8"	10"	1/2 lb.	Lid for TR-50	White, Silver, Black, Red, Green, Yellow, Blue	\$38.00
TR-11	N/A	9 13/16"	10 7/8"	1 lb.	Lid for TR-10	White, Silver, Black, Red, Green, Yellow, Blue	\$38.00

## BASICS\*



CB-1004



P-2200

MODEL	H	W	D	SHIPPING WEIGHT	DESCRIPTION	COLOR/ FINISH	LIST PRICE
CB-1004	11 13/16"	9 11/16"	Ø	5 lbs.	Wastepaper basket Capacity 3.7 gallons	Black powder coated steel	\$75.00
CB-1004-R					Wastepaper basket with Stainless accent trim/bag ring. Capacity 3.7 gallons.	Black powder coated steel	\$79.00
CB-1004-RSS	11 13/16"	9 11/16"	Ø	5 lbs.	Wastepaper basket with Stainless accent trim/bag ring. Capacity 3.7 gallons.	Stainless steel	\$89.00
P-2200	13 3/8"	9 7/8"	Ø	6 lbs.	Wastepaper basket. Capacity 3.6 gallons	Alum. Ral 9006	\$95.00

**\*All Basics products are while supplies last.**

## AXIANE

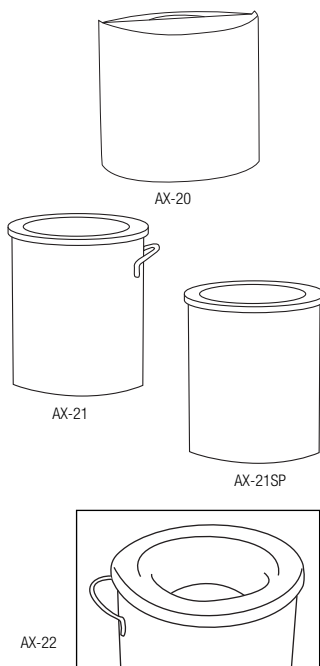

MODEL	H	W	D	SHIPPING WEIGHT	DESCRIPTION	COLOR/ FINISH	LIST PRICE
AX-20	13 3/4"	13"	8 7/8"	7 lbs.	1/2 round wastebasket with handle. Capacity 4.0 gallons.	White, Black, Silver or Sand powder coat	\$205.00
AX-113				1 lb.	Wall mount accessory for AX-20	Black	\$44.00
AX-21	13 13/16"	10 1/4"	Ø	5 lbs.	Round wastebasket with handle. Capacity 4.3 gallons	White, Black, Silver or Sand powder coat	\$205.00
AX-21SP	13 13/16"	10 1/4"	Ø	7 lbs.	Round wastebasket. Capacity 4.3 gallons.	White, Black, Silver or Sand powder coat	\$194.00
AX-22	2 3/16"	10 7/8"	Ø	2 lbs.	Optional flame extinguishing top for AX-21 and AX-21SP units.	White, Black, Silver or Sand powder coat	\$84.00

**See Page 61 for balance of series**

## SILO

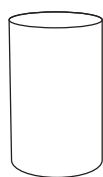

SPB-2538  
SPB-2538-SS

MODEL	H	W	D	SHIPPING WEIGHT	DESCRIPTION	COLOR/ FINISH	LIST PRICE
SPB-2538	14 15/16"	9 13/16"	Ø	6 lbs.	Metal waste bin. Capacity 3.7 gallons	Black, White or Metallic Grey	\$185.00
SPB-2538-SS	14 15/16"	9 13/16"	Ø	6 lbs.	Metal waste bin. Capacity 3.7 gallons	Brushed Stainless Steel	\$340.00

## DROP

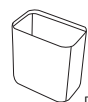

DROP-10



DROP-20

MODEL	H	W	D	SHIPPING WEIGHT	DESCRIPTION	COLOR/ FINISH	LIST PRICE
DROP-10	14 11/16"	13 3/4"	8 11/16"	12 lbs.	Metal waste bin with stainless bag ring. Capacity 7.66 gallons	Textured White Black or Forge Grey	\$360.00 \$395.00
DROP-20	18 7/8"	16 3/4"	8 11/16"	15 lbs.	Metal waste bin with stainless bag ring. Capacity 9.51 gallons	Textured White Black or Forge Grey	\$420.00 \$465.00

## MY PERSONAL RECYCLER

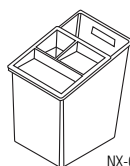

NX-01

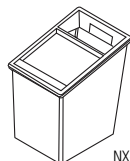

NX-02

MODEL	H	W	D	SHIPPING WEIGHT	DESCRIPTION	COLOR/ FINISH	LIST PRICE
NX-01	16 15/16"	11 13/16"	15 3/4"	7 lbs.	ABS plastic waste container with sliding lid, two storage trays and opening for recyclables. Two removable internal containers, third instant access compartment. Capacity 7.9 gallons.	White or Black body, lid in White, Blue, Green or Yellow	\$135.00
NX-02	16 15/16"	11 13/16"	15 3/4"	7 lbs.	ABS plastic waste container with three openings, two of them with flap opening, two concealed containers and one instant access compartment. Capacity 7.9 gallons.	White or Black body, lid in White, Blue, Green or Yellow	\$135.00

PUP

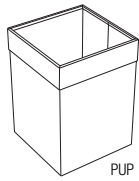

MODEL	H	W	D	SHIPPING WEIGHT	DESCRIPTION	COLOR/ FINISH	LIST PRICE
PUP	13 7/8"	9 13/16"	9 13/16"	9 lbs.	Square metal waste basket with removable top ring that conceals the internal waste bag. Capacity 5.5 gallons.	White body with top ring in Blue, Green or White Silver body with top ring in White, Blue, Green or Silver	\$195.00 \$225.00

CONEE

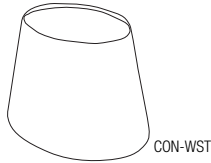

MODEL	H	W	D	SHIPPING WEIGHT	DESCRIPTION	COLOR/ FINISH	LIST PRICE
CON-WST	11 7/16"	15"	Ø"	15 lbs.†	Painted waste bin with bag ring See pg 125 for matching umbrella stand and pg 52 for matching planters (Product available late fall 2016)	Textured Black Ral 9011, Textured White or Forge Grey	\$965.00

SMOKE

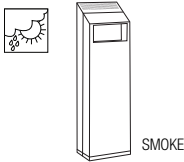

MODEL	H	W	D	SHIPPING WEIGHT	DESCRIPTION	COLOR/ FINISH	LIST PRICE
SMOKE	35 7/16"	9 13/16"	5 7/8"	29 lbs.†	Locking waste bin with ashtray. Secures to the ground. Capacity 5.8 gallons. Suitable for outdoor use.	Textured Bronze	\$625.00

RIGA

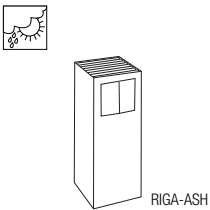

MODEL	H	W	D	SHIPPING WEIGHT	DESCRIPTION	COLOR/ FINISH	LIST PRICE
RIGA-ASH	27 15/16"	9 13/16"	9 13/16"	15 lbs.†	Waste bin with front opening, integrated bag ring and ashtray. Capacity 7.9 gallons.	Stainless Steel with Satin Silver Aluminum top	\$720.00
RIGA-ASH-P	27 15/16"	9 13/16"	9 13/16"	15 lbs.†	Waste bin with front opening, integrated bag ring and ashtray. Capacity 7.9 gallons. Riga Stainless Steel units are suitable for outdoor use under cover. Painted units are for indoor use only. See page 36 & 37 for matching waste receptacles and page 123 for matching umbrella stand.	Grey White Ral 9002 painted body with Satin Silver Aluminum top	\$445.00

RETTO

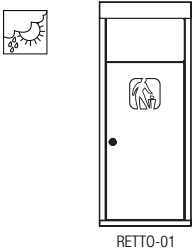

MODEL	H	W	D	SHIPPING WEIGHT	DESCRIPTION	COLOR/ FINISH	LIST PRICE
RETTO-01	43 13/16"	17 11/16"	18 7/8"	93 lbs.†	Outdoor waste receptacle with front opening and galvanized liner. Locking front door with concealed hinges. Can be secured or weighted to the ground. Capacity 26.4 gallons. One icon from selection below included.	Textured Bronze	\$1,035.00

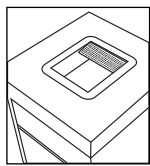

RETTO-02	43 13/16"	17 11/16"	18 7/8"	93 lbs.†	Outdoor waste receptacle with front opening and galvanized liner. Includes rectangular stainless steel ashtray on lid. Locking front door with concealed hinges. Can be secured or weighted to the ground. Capacity 26.4 gallons. One icon from selection below included.	Textured Bronze	\$1,345.00
----------	-----------	-----------	---------	----------	---	-----------------	------------



Waste



Paper



Recycling



Cans



Cans & Bottles



Glass



Organics

+Ships via common carrier.

## BALLOON

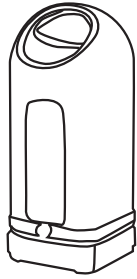

BAL-10

MODEL	H	W	D	SHIPPING WEIGHT	DESCRIPTION	COLOR/ FINISH	LIST PRICE
BAL-10	39 3/8"	15 3/8"	19 15/16"	29 lbs.†	100% recyclable polythene body with base and internal container of recycled plastic. Waste front opening. Triangular snap lock. Body lifts off base to access internal container for easy emptying of trash. Rectangular base can be secured to the ground. One icon from selection below included. Capacity 18.5 gallons.	Body in Green, Yellow, Blue, Red, Grey, White or Dark Green, base in Black	\$675.00

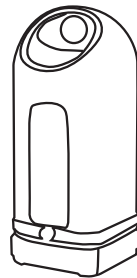

BAL-20

BAL-20	39 3/8"	15 3/8"	19 15/16"	29 lbs.†	100% recyclable polythene body with base and internal container of recycled plastic. Circle front opening. Triangular snap lock. Body lifts off base to access internal container for easy emptying of trash. Rectangular base can be secured to the ground. One icon from selection below included. Capacity 18.5 gallons.	Body in Green, Yellow, Blue, Red, Grey, White or Dark Green, base in Black	\$675.00
--------	---------	---------	-----------	----------	---	--	----------

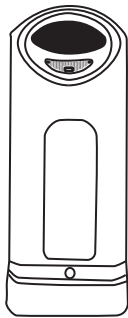

BAL-30

BAL-30	39 3/8"	15 3/8"	19 15/16"	29 lbs.†	100% recyclable polythene body with base and internal container of recycled plastic. Waste front opening with ashtray. Triangular snap lock. Body lifts off base to access internal container for easy emptying of trash. Rectangular base can be secured to the ground. One icon from selection below included. Capacity 18.5 gallons.	Body in Green, Yellow, Blue, Red, Grey, White or Dark Green. Base in Black with Stainless Steel ashtray grill with ash receptacle.	\$835.00
--------	---------	---------	-----------	----------	---	--	----------



ASHTRAY DETAIL



Waste



Paper



Recycling



Cans



Cans & Bottles



Glass



Organics

† Ships via common carrier

## MECORA

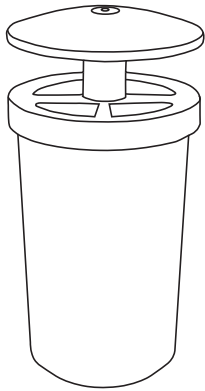

MECORA-50

MODEL	H	W	D	SHIPPING WEIGHT	DESCRIPTION	COLOR/ FINISH	LIST PRICE
MECORA-50	33 7/16"	21 1/2"	Ø	78 lbs.†	Textured steel waste receptacle with one internal compartment and three top openings. Tapered shape with bag rings . Raised weather cover. Locking hinged top for easy removal and changing of bag. Round base must be secured to the ground. Capacity 31.7 gallons.	Textured Bronze	\$1,950.00
MECORA-90	33 7/16"	21 1/2"	Ø	78 lbs.†	Textured steel waste receptacle with one internal compartment and three top openings. Tapered shape with bag rings . Raised weather cover with integrated ashtray. Locking hinged top for easy removal and changing of bag. Round base must be secured to the ground. Capacity 31.7 gallons.	Textured Bronze	\$2,150.00

## LAUSANNE

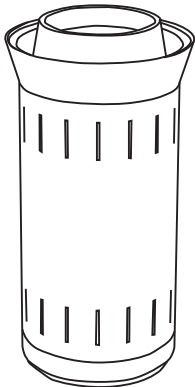







LSN-01  
LSN-02  
LSN-11  
LSN-12

MODEL	H	W	D	SHIPPING WEIGHT	DESCRIPTION	COLOR/ FINISH	LIST PRICE
LSN-01	31 1/2"	17 11/16"	Ø	47 lbs.†	Outdoor wastebasket with bag ring. Painted body with Silver Aluminum top and base. Capacity 31.7 gallons.	Textured Anthracite body with Silver Aluminum top and base	\$1,645.00
LSN-02	33 7/16"	17 11/16"	Ø	47 lbs.†	Outdoor wastebasket with bag ring and ashtray. Painted body with Silver Aluminum top and base. Capacity 31.7 gallons.	Textured Anthracite body with Silver Aluminum top and base	\$1,695.00
LSN-01 & 02 units are suitable for outdoor use under cover.							
LSN-11	31 1/2"	17 11/16"	Ø	47 lbs.†	Outdoor wastebasket with bag ring. Satin Stainless Steel body with Silver Aluminum top and base. Capacity 31.7 gallons.	Satin Stainless Steel body with Silver Aluminum top and base.	\$2,095.00
LSN-12	33 17/16"	17 11/16"	Ø	47 lbs.†	Outdoor wastebasket with bag ring and ashtray. Satin Stainless Steel body with Silver Aluminum top and base. Capacity 31.7 gallons.	Satin Stainless Steel body with Silver Aluminum top and base.	\$2,175.00
Lausanne Satin Stainless Steel models are suitable for outdoor use.							

† Ships via common carrier

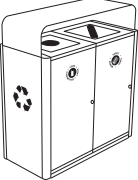
## UMEA

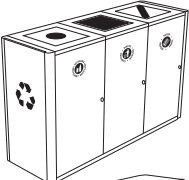
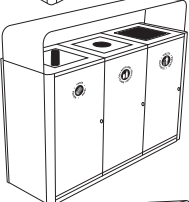
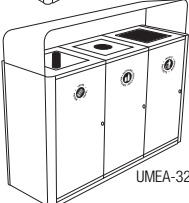
	MODEL	H	W	D	SHIPPING WEIGHT	DESCRIPTION	COLOR/ FINISH	LIST PRICE
 UMEA-10	UMEA-10	35 1/2"	22"	18 1/2"	72 lbs.†	Single 40 gallon compartment waste receptacle with internal rigid liner and locking front opening. Single top opening with painted side panels.	Body colors in Sky White, Britebond Silver or Mineral Bronze. Side panels/hood colors in Sky White, Britebond Silver, Mineral Bronze, Sea Green, Marigold Yellow, Marine Blue or Clementine Orange. Top insert colors in Marigold Yellow, Marine Blue, Clementine Orange, Sky White, Britebond Silver or Mineral Bronze.	\$1,695.00
 UMEA-11	UMEA-11	44 3/4"	22"	18 1/2"	96 lbs.†	Same as Umea 10 but with flat hood.	Same as above.	Add \$315.00
 UMEA-12	UMEA-12	46 3/4"	22"	18 1/2"	101 lbs.†	Same as Umea 10 but with angled hood.	Same as above.	Add \$395.00
 UMEA-20	UMEA-20	35 1/2"	40"	18 1/2"	140 lbs.†	Double 40 gallon compartment waste receptacle with two internal rigid liners and two locking front openings. Two top openings with painted side panels.	Body colors in Sky White, Britebond Silver or Mineral Bronze. Side panels/hood colors in Sky White, Britebond Silver, Mineral Bronze, Sea Green, Marigold Yellow, Marine Blue or Clementine Orange. Top insert colors in Marigold Yellow, Marine Blue, Clementine Orange, Sky White, Britebond Silver or Mineral Bronze.	\$2,695.00
 UMEA-21	UMEA-21	44 3/4"	40"	18 1/2"	164 lbs.†	Same as Umea 20 but with flat hood.	Same as above.	Add \$395.00
 UMEA-22	UMEA-22	46 3/4"	40"	18 1/2"	169 lbs.†	Same as Umea 20 but with angled hood.	Same as above.	Add \$475.00
 UMEA-30	UMEA-30	35 1/2"	58"	18 1/2"	203 lbs.†	Triple 40 gallon compartment waste receptacle with three internal rigid liners and three locking front openings. Three top openings with painted side panels.	Body colors in Sky White, Britebond Silver or Mineral Bronze. Side panels/hood colors in Sky White, Britebond Silver, Mineral Bronze, Sea Green, Marigold Yellow, Marine Blue or Clementine Orange. Top insert colors in Marigold Yellow, Marine Blue, Clementine Orange, Sky White, Britebond Silver or Mineral Bronze.	\$3,795.00
 UMEA-31	UMEA-31	44 3/4"	58"	18 1/2"	227 lbs.†	Same as Umea 30 but with flat hood.	Same as above.	Add \$445.00
 UMEA-32	UMEA-32	46 3/4"	58"	18 1/2"	232 lbs.†	Same as Umea 30 but with angled hood.	Same as above.	Add \$525.00

Some line art shown with optional side panel cutouts.

† Ships via common carrier

UMEA is available with three top opening options.



UMEA Bodies are each available in the following powder coat paint colors.



UMEA Top Inserts, Side Panels and Flat or Angled Hoods are available in the following powder coat paint colors.



**Note:** Colors are approximations and may appear different on your computer screen and in print. Sample chips available.

UMEA is also available with seven optional icon/references for easy sorting and disposal of various types of waste as follows.



## HOW TO ORDER UMEA

When ordering Umea, a selection must be made from each column below and noted on the order (see example below)

Umea Model	Selection #1 Body Color Choice	Selection #2 Top Insert Choice	Selection #3 Top Insert Color Choice	Selection #4 Side Panel/Hood Color Choice	Selection #5 Icon Choice	Selection #6 Icon Color Choice
Umea-10 Umea-11 Umea-12 Single Compartment Unit	Sky White, Britebond Silver, Mineral Bronze	Waste Circle, Paper	Sea Green, Sky White, Britebond Silver, Mineral Bronze, Marigold Yellow, Marine Blue, Clementine Orange	Sea Green, Sky White, Britebond Silver, Mineral Bronze, Marigold Yellow, Marine Blue, Clementine Orange	Waste, Recycling Arrows, Paper, Cans, Plastic, Glass, Organics	White, Dark Gray, Green, Blue, Yellow or Orange
Umea-20 Umea-21 Umea-22 Two Compartment Unit	Sky White, Britebond Silver, Mineral Bronze	Waste Circle, Paper (Choose 2)	Sea Green, Sky White, Britebond Silver, Mineral Bronze, Marigold Yellow, Marine Blue, Clementine Orange (Choose 2)	Sea Green, Sky White, Britebond Silver, Mineral Bronze, Marigold Yellow, Marine Blue, Clementine Orange	Waste, Recycling Arrows, Paper, Cans, Plastic, Glass, Organics (Choose 2)	White, Dark Gray, Green, Blue, Yellow or Orange (Choose 2)
Umea-30 Umea-31 Umea-32 Three Compartment Unit	Sky White, Britebond Silver, Mineral Bronze	Waste Circle, Paper (Choose 3)	Sea Green, Sky White, Britebond Silver, Mineral Bronze, Marigold Yellow, Marine Blue, Clementine Orange (Choose 3)	Sea Green, Sky White, Britebond Silver, Mineral Bronze, Marigold Yellow, Marine Blue, Clementine Orange	Waste, Recycling Arrows, Paper, Cans, Plastic, Glass, Organics (Choose 3)	White, Dark Gray, Green, Blue, Yellow or Orange (Choose 3)

**Note:** For two compartment and three compartment Umea units, please specify top insert and colors for each compartment as units are shipped assembled. Example – for Umea 30 – compartment 1 – waste insert in Clementine Orange, compartment 2 circle insert in Marine Blue, compartment 3 – paper insert in Sea Green.

### Optional Side Panel Cutouts

Umea is available with optional side panel cutouts for an additional list price of \$195.00. Select one only – cutout will be on both side panels.

1. Waste cutout
2. Recycling Arrows cutout
3. Geometric Pattern cutout



### Order Example:

Umea-10/Sky White Body/Marine Blue side panels/Waste opening, Marine Blue/Waste graphic Marine Blue

Umea-21/Britebond Silver body/Sky White side panels & flat hood/Waste opening, Marine Blue; Recycling opening, Clementine Orange/Waste graphic, Marine Blue, Recycling graphic, Clementine Orange/Optional Waste cutout in side panels.

Umea-32/Mineral Bronze body/Sky White side panels and angled hood/Waste opening; Marine Blue; Recycling opening, Clementine Orange; Paper opening, Marigold Yellow/Waste graphic, Marine Blue; Recycling graphic, Clementine Orange; Paper graphic, Marigold Yellow/Optional Flat Hood, Sky White/Optional Geometric pattern cutout in side panels.



## KASKAD



KAS-0918S



KAS-0918M

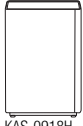

KAS-0918H



MODEL	H	W	D	SHIPPING WEIGHT	DESCRIPTION	COLOR/ FINISH	LIST PRICE
KAS-0918S	12"	9"	18"	18 lbs. †	Painted steel rectangular planter with liner and adjustable glides	Mineral Bronze, Textured White Ral 9010 or Anodized Silver	\$425.00
KAS-0918M	20"	9"	18"	24 lbs. †			\$545.00
KAS-0918H	36"	9"	18"	33 lbs. †			\$665.00

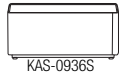

KAS-0936S

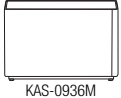

KAS-0936M



KAS-0936H



KAS-0936S	12"	9"	36"	32 lbs. †	Painted steel rectangular planter with liner and adjustable glides	Mineral Bronze, Textured White Ral 9010 or Anodized Silver	\$725.00
KAS-0936M	20"	9"	36"	41 lbs. †			\$855.00
KAS-0936H	36"	9"	36"	56 lbs. †			\$985.00



KAS-1818S



KAS-1818M



KAS-1818S	12"	18"	18"	28 lbs. †	Painted steel square planter with liner and adjustable glides	Mineral Bronze, Textured White Ral 9010 or Anodized Silver	\$545.00
KAS-1818M	20"	18"	18"	34 lbs. †			\$695.00

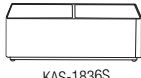

KAS-1836S

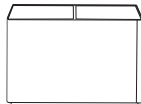

KAS-1836M

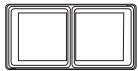

KAS-1836S	12"	18"	36"	49 lbs. †	Painted steel rectangular planter with liner and adjustable glides	Mineral Bronze, Textured White Ral 9010 or Anodized Silver	\$895.00
KAS-1836M	20"	18"	36"	59 lbs. †			\$1,095.00

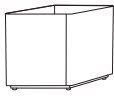

KAS-PS

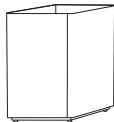

KAS-PM



KAS-PS	12"	13"	28 1/2"	26 lbs. †	Painted steel parallelogram shaped planter with liner and adjustable glides	Mineral Bronze, Textured White Ral 9010 or Anodized Silver	\$585.00
KAS-PM	20"	13"	28 1/2"	38 lbs. †			\$765.00

Note: All 20" and 36" tall Kaskad planters include a 14 1/2" x 26 1/2" polybag for ballast if additional weight is desired for stability. Pea gravel is a recommended material but is not included.

Kaskad's internal liner is 7 3/4" deep and can be removed if it is not being used to contain the plants.

† Ships via common carrier

## KYO

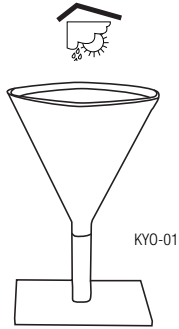

MODEL	H	W	D	SHIPPING WEIGHT	DESCRIPTION	COLOR/ FINISH	LIST PRICE
KYO-01	17 5/16"	15 3/4"	15 3/4"	12 lbs.	Flower pot of roto-molded polyethylene. Self-watering system. Brushed steel square base and post.	Black, White, Anthracite Grey, Mustard or Terracotta	\$645.00
KYO-02	22 7/16"	15 3/4"	15 3/4"	13 lbs.	Flower pot of roto-molded polyethylene. Self-watering system. Brushed steel square base and post.	Black, White, Anthracite Grey, Mustard or Terracotta	\$665.00

Suitable for outdoor use under cover.

## CREPE

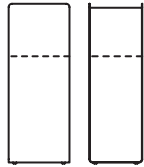

CREPE H



CREPE S



CREPE L

MODEL	H	W	D	SHIPPING WEIGHT	DESCRIPTION	COLOR/ FINISH	LIST PRICE
CREPE H	47 5/8"	18 1/8"	15 3/4"	42 lbs.†	Aluminum indoor/outdoor planter with plastic water saucer and flower pot.	Textured Forge Grey, Textured Black or White Ral 9010	\$2,195.00
CREPE S	16 1/8"	18 1/8"	15 3/4"	15 lbs.	Square aluminum indoor/outdoor planter with plastic water saucer and flower pot.	Textured Forge Grey, Textured Black or White Ral 9010	\$1,255.00
CREPE L	16 1/8"	48 3/4"	15 3/4"	31 lbs.†	Rectangular aluminum indoor/outdoor planter with three plastic water saucers and three flower pots.	Textured Forge Grey, Textured Black or White Ral 9010	\$2,195.00

## LAURA

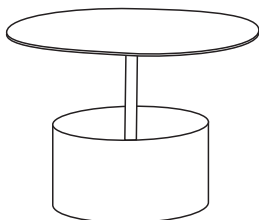

LAURA

MODEL	H	W	D	SHIPPING WEIGHT	DESCRIPTION	COLOR/ FINISH	LIST PRICE
LAURA	19 3/4"	27 5/8"	Ø	36 lbs.†	Round table with planter or storage space in base. Planter is 9 1/2" high x 15 3/4" round. Indoor only.	White Ral 9010	\$1,885.00

† Ships via common carrier

## GREEN CLOUD

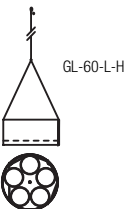
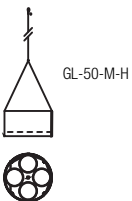
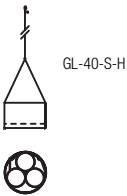
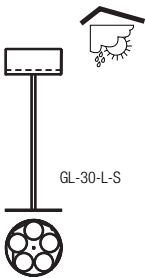
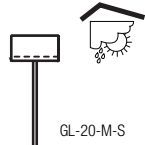
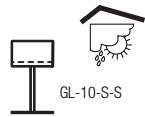

MODEL	H	W	D	SHIPPING WEIGHT	DESCRIPTION	COLOR/ FINISH	LIST PRICE
GL-10-S-S	26 1/4"	14 15/16"	Ø	27 lbs.†	Round standing flower pot in painted steel and aluminum. Includes molded water saucer and three round flower pots. Suitable for outdoor use under cover.	White Ral 9010	\$1,360.00
GL-20-M-S	44 7/8"	17 5/16"	Ø	37 lbs.†	Round standing flower pot in painted steel and aluminum. Includes molded water saucer and four round flower pots. Suitable for outdoor use under cover.	White Ral 9010	\$1,780.00
GL-30-L-S	59 1/16"	20 1/4"	Ø	48 lbs.†	Round standing flower pot in painted steel and aluminum. Includes molded water saucer and five round flower pots. Suitable for outdoor use under cover.	White Ral 9010	\$1,885.00
GL-40-S-H	24 15/16"	14 15/16"	Ø	10 lbs.	Round hanging flower pot in painted steel and aluminum. Includes molded water saucer and three round flower pots. Hanging wire included.  (triangular hanging wire is 15 3/4" long/ceiling chain up to 56 1/2")	White Ral 9010	\$1,360.00
GL-50-M-H	27 11/16"	17 5/16"	Ø	12 lbs.	Round hanging flower pot in painted steel and aluminum. Includes molded water saucer and four round flower pots. Hanging wire included.  (triangular hanging wire is 18 1/2" long/ceiling chain up to 56 1/2")	White Ral 9010	\$1,465.00
GL-60-L-H	30 7/8"	20 1/4"	Ø	14 lbs.	Round hanging flower pot in painted steel and aluminum. Includes molded water saucer and five round flower pots. Hanging wire included.  (triangular hanging wire is 21 5/8" long/ceiling chain up to 56 1/2")	White Ral 9010	\$1,675.00

† Ships via common carrier

## CONEE



CON-SPL  
CON-MPL

MODEL	H	W	D	SHIPPING WEIGHT	DESCRIPTION	COLOR/ FINISH	LIST PRICE
CON-SPL	11 7/16"	15"	Ø	15 lbs.†	Painted aluminum planter with drip tray and flowerpot	Textured Black Ral 9011, Textured White or Textured Forge Grey	\$965.00
CON-MPL	19 11/16"	31 1/2"	Ø	51 lbs.			\$1,995.00

See page 44 for matching waste basket and page 125 for matching umbrella stand. (Product available late fall 2016)

## STILO

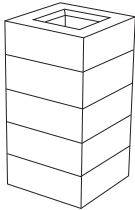

STILO-P

MODEL	H	W	D	SHIPPING WEIGHT	DESCRIPTION	COLOR/ FINISH	LIST PRICE
STILO-P	29 1/2"	15 3/8"	15 3/8"	28 lbs.†	Painted steel planter made from 100% recyclable steel. Removable lid with internal liner for plant material.	Anthracite or White body, lid in Grey, White, Green, Blue or Yellow	\$1,045.00

See page 41 for matching waste receptacle.

## STORE

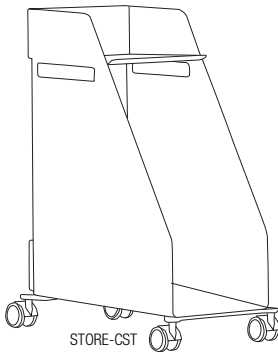

STORE-CST

MODEL	H	W	D	SHIPPING WEIGHT	DESCRIPTION	COLOR/ FINISH	LIST PRICE
STORE-CST	25 3/4"	12 1/2"	21 1/2"	30 lbs.†	Painted steel workspace utility cart with one fixed shelf, a strap handle and color coordinated locking casters.	Textured White Ral 9010 with Light Grey strap or Textured Black Ral 9011, with Anthracite Grey Strap or Forge Grey with Anthracite Grey strap.	\$765.00

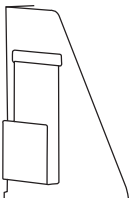

STORE MAG

STORE-MAG	11 7/8"	7 1/8"	1 9/16"	4 lbs.	Optional magazine shelf to hang on either side.	Textured White Ral 9010, Textured Black Ral 9011, Forge Grey, Grey Beige Ral 1019 or Mustard Ral 1012.	\$65.00
-----------	---------	--------	---------	--------	---	--	---------

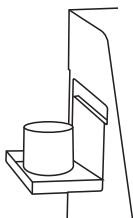

STORE SHELF

STORE-SHELF	4 9/16"	7 3/16"	4 1/2"	2 lbs.	Optional side shelf to hang on either side of unit. Includes cup holder. (Cup not included)	Textured White Ral 9010, Textured Black Ral 9011, Forge Grey, Grey Beige Ral 1019 or Mustard Ral 1012.	\$98.00
-------------	---------	---------	--------	--------	---	--	---------

† Ships via common carrier

## HOLD

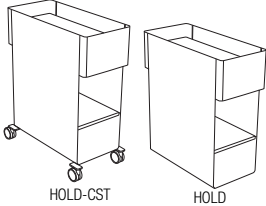
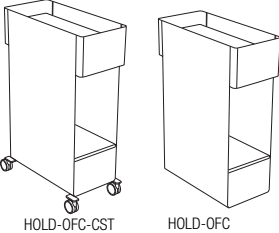
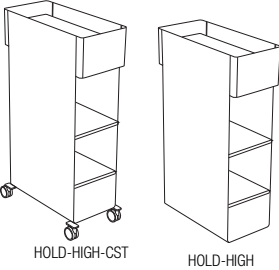
	MODEL	H	W	D	SHIPPING WEIGHT	DESCRIPTION	COLOR/ FINISH	LIST PRICE
	HOLD	20 7/8"	8 5/8"	19"	25 lbs.†	Painted steel utility cart with one fixed shelf and methacrylate top.	Textured White Ral 9010, Textured Black Ral 9011, Forged Grey Ral 1019	\$585.00
	HOLD-CST	23"	10 7/8"	19"	30 lbs.†	Same as above but with locking casters.		\$795.00
	HOLD OFC	29 1/4"	10 3/8"	15"	32 lbs.†	Painted steel utility cart with one fixed shelf and methacrylate top.	Textured White Ral 9010, Textured Black Ral 9011, Forged Grey Ral 1019	\$725.00
	HOLD-OFC-CST	32"	13 3/8"	15"	37 lbs.†	Same as above but with locking casters.		\$960.00
	HOLD HIGH	40 3/8"	9 7/8"	15 1/8"	51 lbs.†	Painted steel utility cart with two fixed shelves and methacrylate top.	Textured White Ral 9010, Textured Black Ral 9011, Forged Grey RAL 1019	\$825.00
	HOLD HIGH-CST	43"	13 3/8"	15 1/8"	56 lbs.†	Same as above but with locking casters.		\$1,070.00

† Ships via common carrier

## HOLD

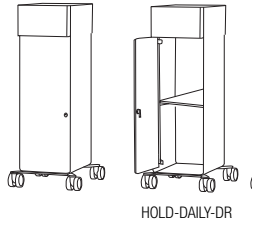

MODEL	H	W	D	SHIPPING WEIGHT	DESCRIPTION	COLOR/ FINISH	LIST PRICE
HOLD-DAILY-DR	36 1/4"	14 1/4"	19 1/8"	37 lbs.†	Painted steel utility cart with one fixed shelf and locking door. 2 1/2" high casters included.	Textured White	\$1,395.00

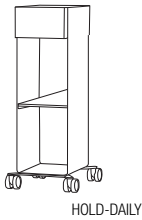

HOLD-DAILY	36 1/4"	14 1/4"	19 1/8"	35 lbs.†	Painted steel utility cart with one fixed shelf. 2 1/2" high casters included.	Textured White	\$1,195.00
------------	---------	---------	---------	----------	--	----------------	------------

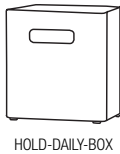

HOLD-DAILY-BOX	19 1/16"	9 1/8"	9 1/8"	2 lbs.	Painted metal storage box for use in either model above.	Textured White, Textured Forge Grey, Textured Black Ral 9011, Mustard Ral 1012 or Grey Beige Ral 1019	\$195.00
----------------	----------	--------	--------	--------	--	--	----------

## ROLLER

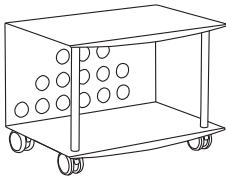

MODEL	H	W	D	SHIPPING WEIGHT	DESCRIPTION	COLOR/ FINISH	LIST PRICE
ROL-4	17"	23 5/8"	15 3/4"	26 lbs.	Painted steel utility cart with two shelves, closed back and 4 locking casters.	White, Black or Silver	\$475.00

† Ships via common carrier

## SUM

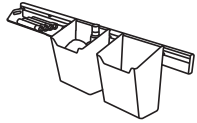

Shown with New Wave accessories



SUM-80



SUM-100



SUM-120

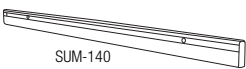

SUM-140

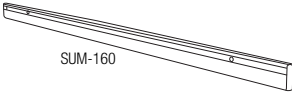

SUM-160

Sum is a wall mounted painted steel tool rail that works with New Wave accessories. (See pg. 58 & 59)

MODEL	H	W	D	SHIPPING WEIGHT	DESCRIPTION	COLOR/ FINISH	LIST PRICE
SUM-80	2"	31 1/2"	1/2"	3 lbs.	Painted steel wall mounted tool rail for use with New Wave accessories	White, Sand, Silver or Black	\$65.00
SUM-100	2"	39 3/8"	1/2"	4 bs.			\$80.00
SUM-120	2"	47 1/4"	1/2"	5 bs.			\$90.00
SUM-140	2"	55 1/8"	1/2"	6 lbs.			\$100.00
SUM-160	2"	63"	1/2"	7 lbs.			\$110.00

## NEW PORT

NEW PORT is a flexible, versatile tool rail system that creates clean, personal "up and off the desk" organization which can be configured in a number of different ways as follows:

- The NEW PORT tool rail is available in varying lengths to accommodate different desk sizes.
- The NEW PORT tool rail can include no privacy screen or a 15 3/8" high privacy screen made of acoustic fabric, melamine, writeable glass or opaque tempered glass.
- The NEW PORT tool rail can be mounted to the desk at multiple heights and in multiple ways.
- The NEW PORT tool rail can be used in single-sided or double-sided desk environments.
- The NEW PORT tool rail can accommodate a wide range of NEW WAVE desk accessories.

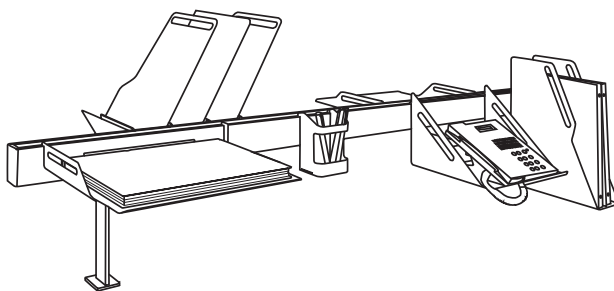

NEW PORT tool rail with no privacy screen and NEW WAVE accessories

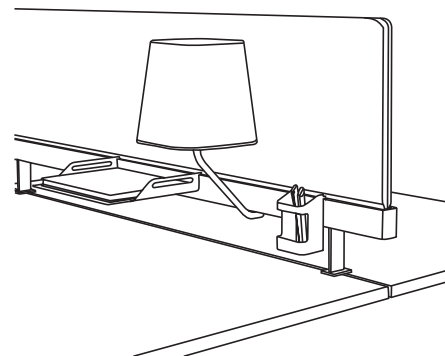

NEW PORT tool rail with privacy screen and NEW WAVE accessories

## HOW TO ORDER NEW PORT

1. First, configure your New Port tool rail system by referring to the Tool Rail & Screen Specification Table below [Table I].
  - a. Select a tool rail length and finish color [Column A].
  - b. If specifying a tool rail without a screen, select a cover color and identify the appropriate model number based on tool rail length [Column B].
  - c. If specifying a tool rail with a screen, choose your desired screen material - Melamine (and corresponding finish color), Acoustic Fabric (and corresponding finish color), Opaque Tempered Glass or Writeable Glass; and identify the appropriate model number based on tool rail length [Column C].
2. Next, select a mounting setup from the Mounting Specification Table below [Table II].
  - a. Select a mounting height [above the desk] for the tool rail [Column A].
  - b. Next, select the appropriate mounting hardware for the desk and identify the appropriate model number based on mounting level [Column B].
3. Finally, select your New Wave accessories from page 58 & 59 which hang off of the New Wave tool rail.

**Table I—TOOL RAIL & SCREEN SPECIFICATION TABLE**

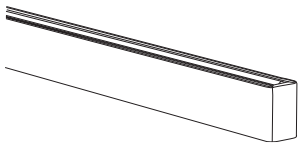
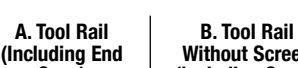
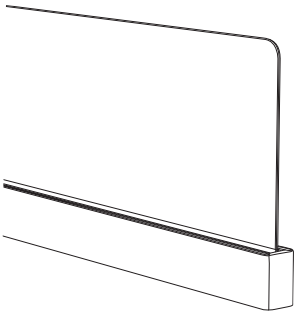

A. Tool Rail (Including End Caps)	B. Tool Rail Without Screen (Including Cover)		C. Tool Rail With Screen							
			Melamine Screen		Acoustic Fabric Screen		Opaque Tempered Glass Screen		Writeable Glass Screen [for use with dry erase markers]	
Tool Rail available in White, Sand, Silver or Black	Tool Rail cover available in White, Blue or Red		Melamine Screens available in White, Sand, Clay, Grey, Tweed, Plum or Aniseed Green. Edge trim White		Acoustic Fabric Screens available in Iroise Blue, Lime Green, Golden Yellow, Garnet, Carmine, Clementine, Steel Grey or Pebble Stone					
Tool Rail Length*	Model	List Price	Model	List Price	Model	List Price	Model	List Price	Model	List Price
21"	NP-53EP	\$140.00	NP-53CM	\$220.00	NP-53CTA	\$385.00	NP-53CVO	\$415.00	NP-53CVT	\$535.00
31 1/2"	NP-80EP	\$160.00	NP-80CM	\$240.00	NP-80CTA	\$425.00	NP-80CVO	\$450.00	NP-80CVT	\$575.00
39 3/8"	NP-100EP	\$185.00	NP-100CM	\$275.00	NP-100CTA	\$495.00	NP-100CVO	\$525.00	NP-100CVT	\$685.00
47 1/4"	NP-120EP	\$205.00	NP-120CM	\$315.00	NP-120CTA	\$565.00	NP-120CVO	\$595.00	NP-120CVT	\$785.00
55 1/8"	NP-140EP	\$230.00	NP-140CM	\$345.00	NP-140CTA	\$635.00	NP-140CVO	\$675.00	NP-140CVT	\$895.00
63"	NP-160EP	\$255.00	NP-160CM	\$395.00	NP-160CTA	\$695.00	NP-160CVO	\$745.00	NP-160CVT	\$995.00

\*Custom lengths available, contact Customer Service for Details



**Table II – MOUNTING SPECIFICATION TABLE**

**B. Mounting Hardware**

A. Mounting Height						
	Single Sided Desk, Side Edge Clamp		Double Sided Desk, Side Edge Clamp		Through Desk*	
Mounting Level	Model	List Price	Model	List Price	Model	List Price
Desktop Level	NP-00P	\$105.00	NP-00M	\$67.00	NP-00F	\$67.00
3 15/16" Above Desk	NP-10P	\$135.00	NP-10M	\$105.00	NP-10F	\$105.00
7 7/8" Above Desk	NP-20P	\$145.00	NP-20M	\$115.00	NP-20F	\$115.00

\*The minimum hole size for mounting through desk is 13/32"

**Table III – OVERALL DIMENSIONS**

Please note, the overall dimensions shown here include the tool rail, screen (if applicable) and mounting hardware.

Overall Dimensions - No Screen (Model NP-EP)												
Toolbar Length	Desktop Level Mount				3 15/16" Above Desk Mount				7 7/8" Above Desk Mount			
	H	W	D	Shipping Weight	H	W	D	Shipping Weight	H	W	D	Shipping Weight
21"	2 3/8"	21"	1- 11/16"	5 lbs.	6 5/16"	21"	1- 11/16"	7 lbs.	10 1/4"	21"	1- 11/16"	8 lbs.
31 1/2"	2 3/8"	31 1/2"	1- 11/16"	7 lbs.	6 5/16"	31 1/2"	1- 11/16"	9 lbs.	10 1/4"	31 1/2"	1- 11/16"	10 lbs.
39 3/8"	2 3/8"	39 3/8"	1- 11/16"	7 lbs.	6 5/16"	39 3/8"	1- 11/16"	9 lbs.	10 1/4"	39 3/8"	1- 11/16"	10 lbs.
47 1/4"	2 3/8"	47 1/4"	1- 11/16"	8 lbs.	6 5/16"	47 1/4"	1- 11/16"	10 lbs.	10 1/4"	47 1/4"	1- 11/16"	11 lbs.
55 1/8"	2 3/8"	55 1/8"	1- 11/16"	9 lbs.	6 5/16"	55 1/8"	1- 11/16"	11 lbs.	10 1/4"	55 1/8"	1- 11/16"	12 lbs.
63"	2 3/8"	63"	1- 11/16"	10 lbs.	6 5/16"	63"	1- 11/16"	12 lbs.	10 1/4"	63"	1- 11/16"	13 lbs.

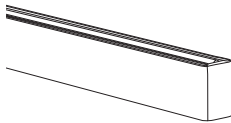

Overall Dimensions - With Screen (Models NP-CVO, CVT, MEL, AFB)												
Toolbar Length	Desktop Level Mount				3 15/16" Above Desk Mount				7 7/8" Above Desk Mount			
	H	W	D	Shipping Weight	H	W	D	Shipping Weight	H	W	D	Shipping Weight
21"	17 3/4"	21"	1- 11/16"	21 lbs.†	21 11/16"	21"	1- 11/16"	23 lbs.†	25 5/8"	21"	1- 11/16"	24 lbs.†
31 1/2"	17 3/4"	31 1/2"	1- 11/16"	23 lbs.†	21 11/16"	31 1/2"	1- 11/16"	25 lbs.†	25 5/8"	31 1/2"	1- 11/16"	26 lbs.†
39 3/8"	17 3/4"	39 3/8"	1- 11/16"	25 lbs.†	21 11/16"	39 3/8"	1- 11/16"	27 lbs.†	25 5/8"	39 3/8"	1- 11/16"	28 lbs.†
47 1/4"	17 3/4"	47 1/4"	1- 11/16"	28 lbs.†	21 11/16"	47 1/4"	1- 11/16"	30 lbs.†	25 5/8"	47 1/4"	1- 11/16"	31 lbs.†
55 1/8"	17 3/4"	55 1/8"	1- 11/16"	31 lbs.†	21 11/16"	55 1/8"	1- 11/16"	33 lbs.†	25 5/8"	55 1/8"	1- 11/16"	34 lbs.†
63"	17 3/4"	63"	1- 11/16"	35 lbs.†	21 11/16"	63"	1- 11/16"	37 lbs.†	25 5/8"	63"	1- 11/16"	38 lbs.†

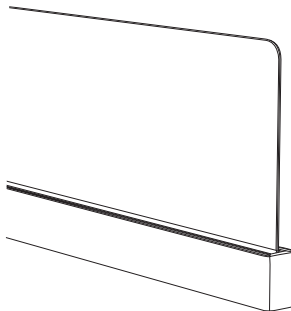

† Ships via common carrier

## NEW WAVE ACCESSORIES

NEW WAVE Accessories are painted steel accessories that can be used with the **SUM** wall mounted tool rail as well as on one or both sides of the **NEW PORT** desk mounted tool rail being used with or without privacy screens.

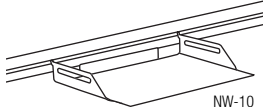
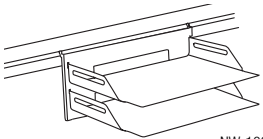
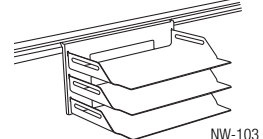
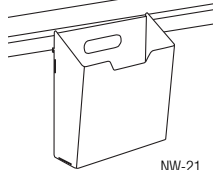
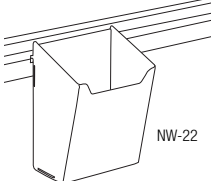
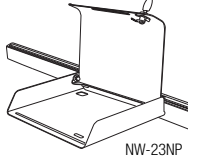
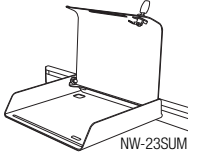
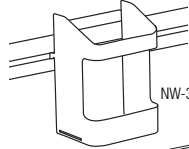
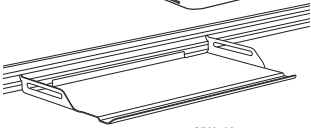
MODEL	H	W	D	SHIPPING WEIGHT	DESCRIPTION	COLOR/ FINISH	LIST PRICE
 NW-10	1 3/4"	13 1/2"	10 3/8"	4 lbs	Mail tray for use on New Port or Sum tool rail	White, Sand, Silver or Black	\$70.00
 NW-102	6 11/16"	13 1/2"	10 3/8"	9 lbs	Two stacked mail trays for use on New Port or Sum tool rail Use with 3 15/16" or 7 7/8" uprights	White, Sand, Silver or Black	\$200.00
 NW-103	10 1/4"	13 1/2"	10 3/8"	14 lbs	Three stacked mail trays for use on New Port or Sum tool rail Use with 7 7/8" uprights only	White, Sand, Silver or Black	\$265.00
 NW-21	11 11/16"	10 7/16"	4 5/16"	2 lbs	Paper box for 8 1/2" x 11" paper for use on New Port or Sum tool rail Use with 7 7/8" uprights only	White, Sand, Silver or Black	\$95.00
 NW-22	7 7/16"	5 3/8"	4 5/8"	2 lbs.	Multi purpose storage cup for use on New Port or Sum toolrail Use with 3 15/16" or 7 7/8" uprights	White, Sand, Silver or Black	\$55.00
 NW-23NP	2"	11 13/16"	9 7/8"	5 lbs.	Locking box to secure digital tools (iPad, smart phone, etc.) on New Port toolrail. Includes cable hole to allow connection for charger. Use with 3 15/16" or 7 7/8" uprights	White, Sand, Silver or Black	\$165.00
 NW-23SUM	2"	11 13/16"	9 7/8"	5 lbs.	Locking box to secure digital tools (iPad, smart phone, etc.) on SUM toolrail. Includes cable hole to allow connection for charger.	White, Sand, Silver or Black	\$165.00
 NW-30	4 13/16"	3 1/4"	2 1/2"	1 lb.	Pencil cup for use on New Port or Sum toolrail Use with 3 15/16" or 7 7/8" uprights	White, Sand, Silver or Black	\$35.00
 NW-40	1 7/8"	17 5/16"	10 3/8"	5 lbs.	Shelf with pencil tray for use on New Port or Sum toolrail	White, Sand, Silver or Black	\$95.00

# NEW WAVE ACCESSORIES

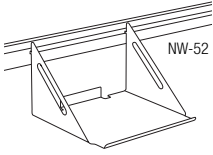
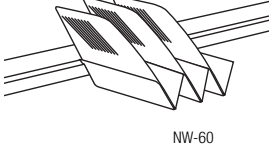
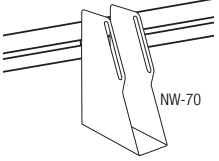
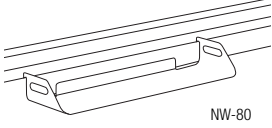
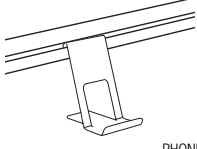
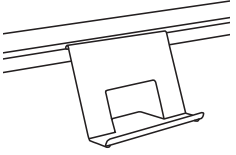
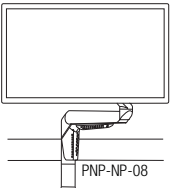
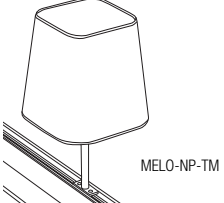
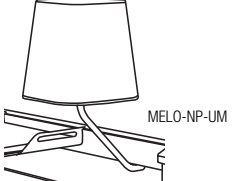
	MODEL	H	W	D	SHIPPING WEIGHT	DESCRIPTION	COLOR/ FINISH	LIST PRICE
	NW-52	6 7/8"	11"	10 1/4"	2 lbs.	Phone support tray for use on New Port or Sum toolrail	White, Sand, Silver or Black	\$85.00
						Use with 3 15/16" or 7 7/8" uprights only.		
	NW-60	10 3/8"	13 5/8"	9 7/8"	6 lbs	3 section sorter for use on New Port or Sum toolrail	White, Sand, Silver or Black	\$125.00
						Use with 3 15/16" or 7 7/8" uprights only.		
	NW-70	13 13/16"	4"	10 1/4"	5 lbs	Binder support for use on New Port or Sum toolrail	White, Sand, Silver or Black	\$75.00
						Use with 7 7/8" uprights only		
	NW-80	1 5/16"	10 1/4"	3 5/16"	1 lb.	Pencil tray for use on New Port or Sum toolrail	White, Sand, Silver or Black	\$40.00
	PHONE-NW	3 5/8"	2 3/8"	2 7/8"	1 lb.	Smart phone support for use on New Port or Sum toolrail	White, Sand, Silver or Black	\$50.00
						Use with 3 15/16" or 7 7/8" uprights only.		
	TABLET-NW	5 3/4"	8 7/8"	4 3/16"	2 lbs.	Tablet support for use on New Port or Sum toolrail	White, Sand, Silver or Black	\$80.00
						Use with 3 15/16" or 7 7/8" uprights only.		
	PNP NP-08				8 lbs.	Monitor arm with 3 articulations allowing multi-directional use of the screen. Height adjustment from 9 11/16" to 20 1/16". Depth adjustment from 4 3/8" to 18 1/2". Vesa support for 75 and 100 mm. For screen weight of 7.1 to 19.8 lbs.	White, Silver or Black with chrome arm	\$595.00
	MELO-NP-TM	16"	8 3/4"	8 3/4"	3 lbs.	Lamp with square shade that attaches to top of New Port toolrail with no screen	Shade in White, Red or Purple. Arm in White, Sand, Silver or Black.	\$365.00
	MELO-NP-UM	17 1/2"	8 3/4"	8 3/4"	3 lbs.	Lamp with square shade that mounts below New Port toolrail when using a screen	Shade in White, Red or Purple. Arm in White, Sand, Silver or Black.	\$365.00
						Use with 3 15/16" or 7 7/8" uprights only.		

New Wave accessories can in certain cases be used with, or customized to fit, other manufacturers slat wall systems. Contact customer service for details.

## REST

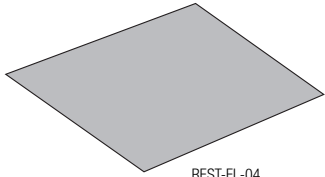

REST-FL-04  
REST-LT-04

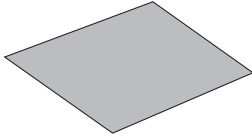

REST-FL-05  
REST-LT-05

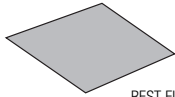

REST-FL-07  
REST-LT-07

MODEL	H	W	D	SHIPPING WEIGHT	DESCRIPTION	COLOR/ FINISH	LIST PRICE
REST-FL-04	16"	22"	3/16"	1 lbs.	Faux Leather large desk pad	Black, Dark Blue, Maroon, Chocolate, Beige	\$130.00
REST-FL-05	12"	18"	3/16"	1 lbs.	Faux Leather small desk pad	Black, Dark Blue, Maroon, Chocolate, Beige	\$108.00
REST-FL-07	4 1/2"	4 1/2"	3/16"	1 lbs.	Set of four coasters in Faux Leather	Black, Dark Blue, Maroon, Chocolate, Beige	\$97.00
REST-LT-04	16"	22"	3/16"	1 lbs.	Leather large desk pad	Black	\$389.00
REST-LT-05	12"	18"	3/16"	1 lbs.	Leather small desk pad	Black	\$270.00
REST-LT-07	4 1/2"	4 1/2"	3/16"	1 lbs.	Set of four leather coasters	Black	\$108.00

Custom colors, sizes, shapes, logo and imprinting available. Call customer service for details.



BLACK



DARK BLUE



MAROON







CHOCOLATE



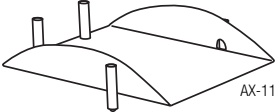
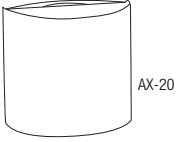
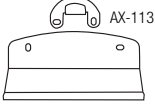
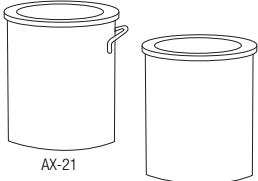
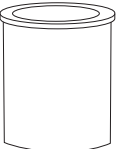

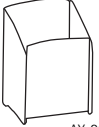
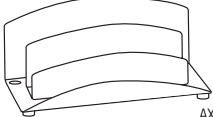
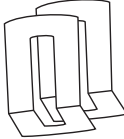
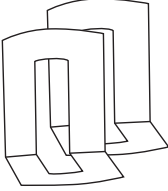
BEIGE

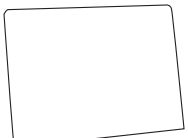
## AXIANE

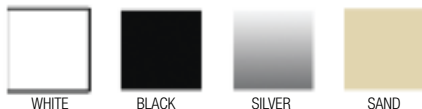
	MODEL	H	W	D	SHIPPING WEIGHT	DESCRIPTION	COLOR/ FINISH	LIST PRICE
	AX-11	3 3/16"	11 7/16"	14"	3 lbs	Stackable mail tray with anti-skid pads	White, Black, Silver or Sand powder coat	\$74.00
	AX-20	13 3/4"	13"	8 7/8"	7 lbs	1/2 round wastebasket with handle. Capacity 4.0 gallons	White, Black, Silver or Sand powder coat	\$205.00
	AX-113				1 lbs	Wall mount accessory for AX-20	Black	\$44.00
	AX-21	13 13/16"	10 1/4"	Ø	5 lbs	Round wastebasket with handle. Capacity 4.3 gallons	White, Black, Silver or Sand powder coat	\$205.00
	AX-21SP	13 13/16"	10 1/4"	Ø	5 lbs	Round wastebasket. Capacity 4.3 gallons	White, Black, Silver or Sand powder coat	\$194.00
	AX-22	2 3/16"	10 7/8"	Ø	2 lbs	Optional flame extinguishing top for AX21 & AX21SP units	White, Black, Silver or Sand powder coat	\$84.00
	AX-30	5 1/4"	3 3/16"	2 9/16"	1 lb	Pencil jar	White, Black, Silver or Sand powder coat	\$42.00
	AX-40	5 1/4"	10 1/4"	5 1/8"	3 lbs	Vertical file/3 sections	White, Black, Silver or Sand powder coat	\$79.00
	AX-60	5 7/8"	3 15/16"	4 3/8"	1 lb	Set of two small bookends	White, Black, Silver or Sand powder coat	\$61.00
	AX-70	7 7/8"	5 1/2"	5 1/2"	2 lbs	Set of two large bookends	White, Black, Silver or Sand powder coat	\$80.00
	AX-82	1 1/4"	10 9/16"	3 3/8"	1 lb	Pen tray	White, Black, Silver or Sand powder coat	\$63.00
	AX-90	1 5/16"	5/8"	3 7/8"	1 lb	Post-It™ dispenser	White, Black, Silver or Sand powder coat	\$37.00
	AX-110	N/A	28 3/8"	20 1/2"	3 lbs	Large desk pad	Black or Anthracite polyurethane foam	\$294.00

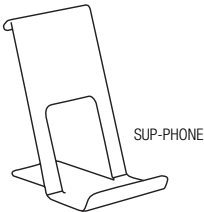

## PHONE, TABLET AND LAPTOP SUPPORTS

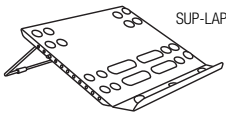
MODEL	H	W	D	SHIPPING WEIGHT	DESCRIPTION	COLOR/ FINISH	LIST PRICE
 SUP-PHONE	3 5/8"	2 3/8"	2 7/8"	1 lbs.	Desktop stand for smart phone	White, Sand, Black or Silver	\$45.00
 SUP-TABLET	5 3/4"	8 7/8"	4 3/16"	2 lbs.	Desktop stand for tablet	White, Sand, Black or Silver	\$80.00
 SUP-LAP	2 3/8"	11 3/4"	10 1/4"	3 lbs.	Desktop stand for laptop with tilt adjustment from 40 to 65 degrees.	White, Sand, Black or Silver	\$125.00

## PUP

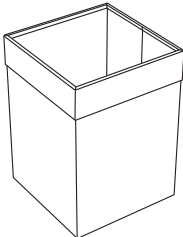
MODEL	H	W	D	SHIPPING WEIGHT	DESCRIPTION	COLOR/ FINISH	LIST PRICE
 PUP	13 7/8"	9 13/16"	9 13/16"	9 lbs.	Square metal waste basket with removable top ring that conceals the internal waste bag. Capacity 5.5 gallons.	White body with top ring in Blue, White or Green	\$195.00
							Silver body with top ring in White, Blue, Green or Silver

## CONEE

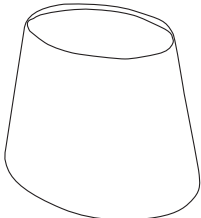
MODEL	H	W	D	SHIPPING WEIGHT	DESCRIPTION	COLOR/ FINISH	LIST PRICE
 CON-WST	11 7/16"	15"	∅	15 lbs.†	Painted waste bin with bag ring	Textured Black Ral 9011, Textured White or Textured Forge Grey	\$965.00
See pg. 125 for marching umbrella stand and pg 52 for matching planters (Product available late fall 2016)							

## SORTMATE

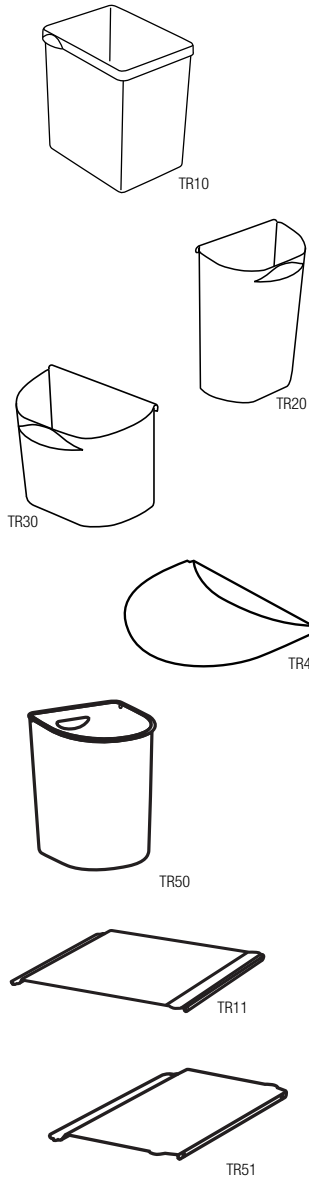

MODEL	H	W	D	SHIPPING WEIGHT	DESCRIPTION	COLOR/ FINISH	LIST PRICE
TR-10-REC	13 3/8"	13 1/16"	9 5/8"	5 lbs.	6.9 gallon main bin	Recycled Black polypropylene	\$65.00
TR-10-PP	13 3/8"	13 1/16"	9 5/8"	5 lbs.	6.9 gallon main bin	White or Silver polypropylene	\$97.00
TR-20-REC	13 5/8"	9 5/16"	6 13/16"	3 lbs.	2.4 gallon large side bin	Recycled Black polypropylene	\$45.00
TR-20-PP	13 5/8"	9 5/16"	6 13/16"	3 lbs.	2.4 gallon large side bin	White or Silver polypropylene	\$61.00
TR-30-REC	7 3/16"	9 5/16"	6 13/16"	1 lb.	1.3 gallon small side bin	Recycled Black polypropylene	\$29.00
TR-30-PP	7 3/16"	9 5/16"	6 13/16"	1 lb.	1.3 gallon small side bin	White or Silver polypropylene	\$41.00
TR-40	N/A	9 5/16"	6 13/16"	1/4 lb.	Lid for TR20 and TR30	White, Black, Blue, Red, Green, Yellow or Silver	\$20.00
TR-50-REC	13 5/8"	10 1/16"	10 3/16"	4 lbs.	4.75 gallon bin	Recycled Black polypropylene	\$47.00
TR-50-PP	13 5/8"	10 1/16"	10 3/16"	4 lbs.	4.75 gallon bin	White or Silver polypropylene	\$95.00
TR-51	N/A	6 3/8"	10"	1/2 lb.	Lid for TR-50	White, Silver, Black, Red, Green, Yellow, Blue	\$38.00
TR-11	N/A	9 13/16"	10 7/8"	1 lb.	Lid for TR-10	White, Silver, Black, Red, Green, Yellow, Blue	\$38.00

## BASICS\*



CB-1004



P-2200

See pg. 125 for marching umbrella stand and pg 52 for matching planters

MODEL	H	W	D	SHIPPING WEIGHT	DESCRIPTION	COLOR/ FINISH	LIST PRICE
CB-1004	11 13/16"	9 11/16"	Ø	5 lbs.	Wastepaper basket Capacity 3.7 gallons	Black powder coated steel	\$75.00
CB-1004-R					Wastepaper basket with Stainless accent trim/bag ring. Capacity 3.7 gallons.	Black powder coated steel	\$79.00
CB-1004-RSS	11 13/16"	9 11/16"	Ø	5 lbs.	Wastepaper basket with Stainless accent trim/bag ring. Capacity 3.7 gallons.	Stainless steel	\$89.00
P-2200	13 3/8"	9 7/8"	Ø	6 lbs.	Wastepaper basket. Capacity 3.6 gallons	Alum. Ral 9006	\$95.00

**\*All Basics products are while supplies last.**

## AXIANE

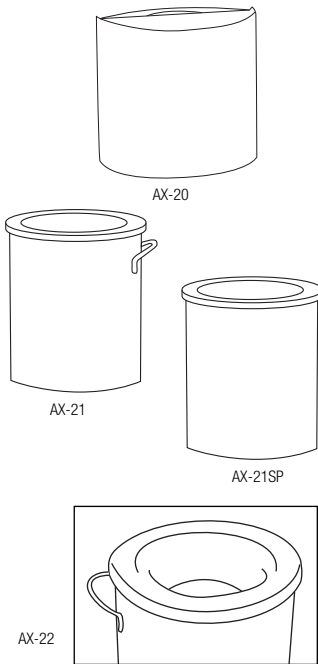

MODEL	H	W	D	SHIPPING WEIGHT	DESCRIPTION	COLOR/ FINISH	LIST PRICE
AX-20	13 3/4"	13"	8 7/8"	7 lbs.	1/2 round wastebasket with handle. Capacity 4.0 gallons.	White, Black, Silver or Sand powder coat	\$205.00
AX-113				1 lb.	Wall mount accessory for AX-20	Black	\$44.00
AX-21	13 13/16"	10 1/4"	Ø	5 lbs.	Round wastebasket with handle. Capacity 4.3 gallons	White, Black, Silver or Sand powder coat	\$205.00
AX-21SP	13 13/16"	10 1/4"	Ø	7 lbs.	Round wastebasket. Capacity 4.3 gallons.	White, Black, Silver or Sand powder coat	\$194.00
AX-22	2 3/16"	10 7/8"	Ø	2 lbs.	Optional flame extinguishing top for AX-21 and AX-21SP units.	White, Black, Silver or Sand powder coat	\$84.00

See Page 61 for balance of series

## SILO

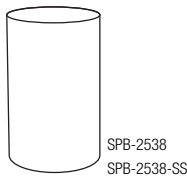

MODEL	H	W	D	SHIPPING WEIGHT	DESCRIPTION	COLOR/ FINISH	LIST PRICE
SPB-2538	14 15/16"	9 13/16"	Ø	6 lbs.	Metal waste bin. Capacity 3.7 gallons	Black, White or Metallic Grey	\$185.00
SPB-2538-SS	14 15/16"	9 13/16"	Ø	6 lbs.	Metal waste bin. Capacity 3.7 gallons	Brushed Stainless Steel	\$340.00

## DROP

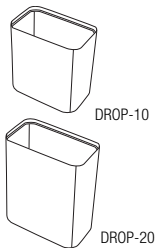

MODEL	H	W	D	SHIPPING WEIGHT	DESCRIPTION	COLOR/ FINISH	LIST PRICE
DROP-10	14 11/16"	13 3/4"	8 11/16"	12 lbs.	Metal waste bin with stainless bag ring. Capacity 7.66 gallons	Textured White	\$360.00
DROP-20	18 7/8"	16 3/4"	8 11/16"	15 lbs.	Metal waste bin with stainless bag ring. Capacity 9.51 gallons	Forge Grey or Black	\$395.00
						Textured White	\$420.00
						Forge Grey or Black	\$465.00

## MY PERSONAL RECYCLER

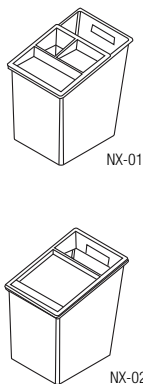

MODEL	H	W	D	SHIPPING WEIGHT	DESCRIPTION	COLOR/ FINISH	LIST PRICE
NX-01	16 15/16"	11 13/16"	15 3/4"	7 lbs.	ABS plastic waste container with sliding lid, two storage trays and opening for recyclables. Two removable internal containers, third instant access compartment. Capacity 7.9 gallons.	White or Black body, lid in White, Blue, Green or Yellow	\$135.00
NX-02	16 15/16"	11 13/16"	15 3/4"	7 lbs.	ABS plastic waste container with three openings, two of them with flap opening, two concealed containers and one instant access compartment. Capacity 7.9 gallons.	White or Black body, lid in White, Blue, Green or Yellow	\$135.00



## RELAX



RP1

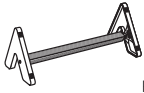

RP2

MODEL	H	W	D	SHIPPING WEIGHT	DESCRIPTION	COLOR/ FINISH	LIST PRICE
RP1	8 1/8"	20 1/2"	9 1/2"	3 lbs.	Foot rest with 3 adjustable positions	Black rest with silver frame or silver rest with black frame	\$135.00
RP2	8 1/8"	20 1/2"	9"	2 lbs.	Foot bar with 3 adjustable positions	Black or Silver w/Black	\$115.00

## FLOD



FLOD

MODEL	H	W	D	SHIPPING WEIGHT	DESCRIPTION	COLOR/ FINISH	LIST PRICE
FLOD	33 1/16"	14 15/16"	16 5/16"	13 lbs.	Polyethylene barstool with integrated footrest. Indoor and outdoor use – 100% recyclable. Can be provided with plug that allows you to fill unit with pea gravel for outdoor use.	White Ral 9003, Grey Ral 7022, Pistachio Ral 1027, Red Ral 2002, Light Blue Pantone P628U or Brown Pantone P408U	\$520.00
FLO-011					Plug for Flod unit to be used when filling unit with pea gravel. (Must be ordered separately.)		N/C

Flod meets or exceeds the minimum requirements per ANSI/BIFMA X5.1-2011 office chairs.

## CALMA

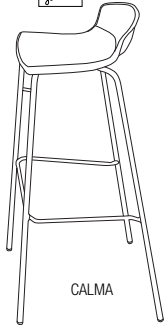

CALMA

MODEL	H	W	D	SHIPPING WEIGHT	DESCRIPTION	COLOR/ FINISH	LIST PRICE
CALMA	30 5/16"	14 1/2"	14 3/16"	44 lbs.†	Stool made of techno polymer seat with painted frame. Stackable 5 high for storage. Suitable for indoor and outdoor use. Assembly required. <b>Sold in Cartons of 4 only.</b>	Frame in White, seat in Black, White, Green	1,180.00 per carton of 4 (\$295.00 ea.)
					Calma meets or exceeds the minimum requirements per ANSI/BIFMA X5.1-2011 office chairs.	Beige, Red, Dark Blue, Pearl Grey, Orange and Pink as special order.	\$1,300.00 per carton of 4 (325.00 ea.)

\$

## ZED



ZED

MODEL	H	W	D	SHIPPING WEIGHT	DESCRIPTION	COLOR/ FINISH	LIST PRICE
ZED	26 3/16" to 30 5/16"	16 1/16"	15 15/16"	60 lbs.†	Polyurethane with steel post frame, chrome plated footrest and base. Swivel seat with gas height adjustment	White, Silver, Black, Pistachio, Purple, Red	\$935.00

Zed meets or exceeds the minimum requirements per ANSI/BIFMA X5.1-2011 office chairs.

† Ships via common carrier

## GINLET

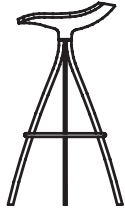

GINLET-K  
GINLET-B

MODEL	H	W	D	SHIPPING WEIGHT	DESCRIPTION	COLOR/ FINISH	LIST PRICE
GINLET-K	25 9/16"	19 5/16"	15 3/8"	16 lbs.	Kitchen stool with polyurethane swivel seat, painted frame and chrome foot rest.	Ral Aluminum 9006 frame, seat in Black, Grey Ral 7021, Olive Green Ral 6003, Beige Grey Ral 7006 or Red Brown Ral 8012	\$795.00
GINLET-B	32 11/16"	19 5/16"	15 3/8"	17 lbs.	Bar stool with polyurethane swivel seat, painted frame and chrome footrest.		\$825.00

Ginlet meets or exceeds the minimum requirements per ANSI/BIFMA X5.1-2011 office chairs.

## NUTA

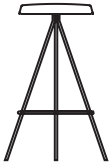

NUTA-K01

MODEL	H	W	D	SHIPPING WEIGHT	DESCRIPTION	COLOR/ FINISH	LIST PRICE
NUTA -K01	23 5/8"	16 1/8"	16 1/8"	11 lbs.	Kitchen stool with beech seat and chrome frame.	Beech seat with chrome frame	\$475.00
NUTA -K02					Kitchen stool with stainless matte seat and chrome frame.	Stainless matte seat and chrome frame	\$495.00
NUTA -K03					Kitchen stool with grey polyurethane seat and chrome frame.	Grey Ral 7021 polyurethane seat and chrome frame	\$550.00
NUTA -K04					Kitchen stool with Black painted seat and frame.	Black Ral 9004 seat and frame.	\$385.00



NUTA-B01

NUTA -B01	29 1/2"	16 1/8"	16 1/8"	13 lbs.	Bar stool with beech seat and chrome frame.	Beech seat with chrome frame	\$495.00
NUTA -B02					Bar stool with stainless matte seat and chrome frame.	Stainless matte seat with chrome frame	\$520.00
NUTA-B03					Bar stool with grey polyurethane seat and chrome frame.	Grey Ral 7021 polyurethane seat with chrome frame	\$575.00
NUTA-B04					Bar stool with Black painted seat and frame.	Black Ral 9004 seat and frame	\$415.00

Nuta meets or exceeds the minimum requirements per ANSI/BIFMA X5.1-2011 office chairs.

## RIVISTA



RIVISTA-STL

MODEL	H	W	D	SHIPPING WEIGHT	DESCRIPTION	COLOR/ FINISH	LIST PRICE
RIVISTA-STL	47 11/16"	17 3/4"	17 3/4"	49 lbs. †	Stool made of techno polymer seat with painted frame. Stackable 4 high for storage. Suitable for indoor and outdoor use. Assembly required. <b>Sold in Cartons of 4 only.</b>	Frame in White, seat in White with Grey insert, Black with White insert or Caramel with White insert  Red with White insert, Turtledove with White insert as special order	\$1,380.00 per carton of 4 (\$345.00 ea.)  \$1,520.00 per carton of 4 (\$380.00 ea.)

Rivista meets or exceeds the minimum requirements per ANSI/BIFMA X5.1-2011 office chairs.



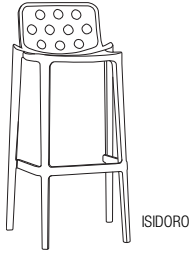

† Ships via common carrier

## ISIDORO

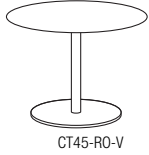

MODEL	H	W	D	SHIPPING WEIGHT	DESCRIPTION	COLOR/ FINISH	LIST PRICE
ISI-STL	38 3/16"	18 29/32"	18 1/8"	45 lbs.†	Stool made of techno polymer with co-injected metal frame. Stackable 6 high for storage. Suitable for indoor and outdoor use. <b>Sold in Cartons of 4 only.</b>	White or Light Grey	\$1,060.00 per carton of 4 (\$265.00 ea.)
Isidoro meets or exceeds the minimum requirements per ANSI/BIFMA X5.1-2011 office chairs.						Sage Green, Bordeaux, Turtledove, Sand or Grey	\$1,140.00 per carton of 4 (\$285.00 ea.)

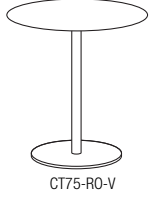
## COOLTIME TABLES

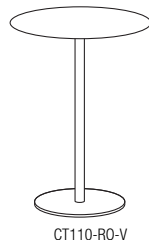
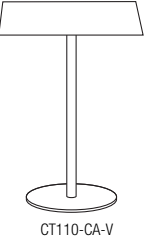
MODEL	H	W	D	SHIPPING WEIGHT	DESCRIPTION	COLOR/ FINISH	LIST PRICE
 CT45-RO-V	17 3/4"	23 5/8"	Ø	37 lbs.†	Low table with round glass top, round painted base	Top in Natural glass, base and column in Silver, Black or White	\$1,025.00
 CT45-CA-V	17 3/4"	23 5/8"	23 5/8"	46 lbs.†	Low table with square glass top, round painted base	Top in Natural glass, base and column in Silver, Black or White	\$1,025.00
 CT75-RO-V	29 9/16"	23 5/8"	Ø	38 lbs.†	Medium height table with round glass top, round painted base	Top in Natural glass, base and column in Silver, Black or White	\$1,045.00
 CT75-CA-V	29 9/16"	23 5/8"	23 5/8"	47 lbs.†	Medium height table with square glass top, round painted base	Top in Natural glass, base and column in Silver, Black or White	\$1,045.00
 CT110-RO-V	43 3/8"	23 5/8"	Ø	39 lbs.†	High table with round glass top, round painted base	Top in Natural glass, base and column in Silver, Black or White	\$1,195.00
 CT110-CA-V	43 3/8"	23 5/8"	23 5/8"	48 lbs.†	High table with square glass top, round painted base	Top in Natural glass, base and column in Silver, Black or White	\$1,195.00
BASE-SR1		19 11/16"	Ø	28 lbs.†	Optional larger base for use on CT110x2	Silver, Black or White	\$35.00
BASE-SR2		19 11/16"	Ø	47 lbs.†	Optional larger, heavier base for use on CT110x2	Silver, Black or White	\$355.00
For CT110 high tables, optional larger base (SR1) or larger, heavier base (SR2) can be substituted for standard base.							

BASE-SR1 / BASE-SR2

† Ships via common carrier

## MILL



MODEL	H	W	D	SHIPPING WEIGHT	DESCRIPTION	COLOR/ FINISH	LIST PRICE
MILL-M	19 7/8"	17 3/4"	Ø	18 lbs.†	Table with painted steel Y base and round top in lacquered MDF finish. Top is 17 3/4" round.	Base in Textured Forged Grey, Black Ral 9011 or White Ral 9010 finish. Top in Black or White lacquered MDF.	\$995.00
MILL-G	19 3/4"	17 3/4"	Ø	21 lbs.†	Table with painted steel Y base and round top in textured glass. Top is 17 3/4" round.	Base in Textured Forged Grey, Black Ral 9011 or White Ral 9010 finish. Top in transparent tempered glass.	\$910.00
MILL-GC	19 3/4"	17 3/4"	Ø	21 lbs.†	Table with chromed steel Y base and round top in tempered glass. Top is 17 3/4" round.	Chrome Base with top in transparent tempered glass	\$965.00

## CELES

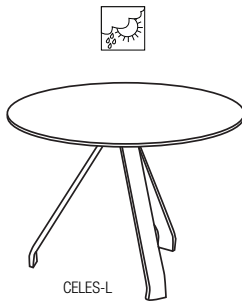

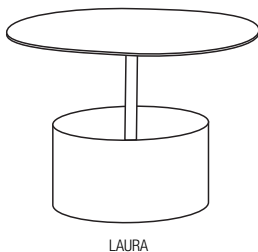

MODEL	H	W	D	SHIPPING WEIGHT	DESCRIPTION	COLOR/ FINISH	LIST PRICE
CELES-L	15 5/8"	19 1/2"	18 3/4"	14 lbs.	Side table constructed of painted aluminum for indoor and outdoor use.	Grey Beige Ral 1019, Mustard Ral 1012, Black Ral 9011 or White Ral 9010 finish	\$1,395.00
CELES-M	13 5/8"	19 1/2"	18 3/4"	13 lbs.	Side table constructed of painted aluminum for indoor and outdoor use.	Grey Beige Ral 1019, Mustard Ral 1012, Black Ral 9011 or White Ral 9010 finish	\$1,375.00
CELES-S	11 11/16"	19 1/2"	18 3/4"	13 lbs.	Side table constructed of painted aluminum for indoor and outdoor use.	Grey Beige Ral 1019, Mustard Ral 1012, Black Ral 9011 or White Ral 9010 finish	\$1,360.00

## LAURA



MODEL	H	W	D	SHIPPING WEIGHT	DESCRIPTION	COLOR/ FINISH	LIST PRICE
LAURA	19 3/4"	27 5/8"	Ø	36 lbs.†	Round table with planter or storage space in base. Planter area is 9 1/2" high x 15 3/4" round. Indoor only.	White Ral 9010	\$1,885.00

## OXI BISTROT

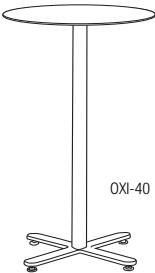
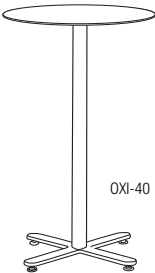
	MODEL	H	W	D	SHIPPING WEIGHT	DESCRIPTION	COLOR/ FINISH	LIST PRICE
	OXI-10	29 1/8"	23 5/8"	Ø	38 lbs.†	Chair height table with cross shaped central base in painted finish. Round top in high pressure phenolic finish. Adjustable glides. Includes hanging bracket for purse/bags.	Post and base in Black Ral 9004 or Grey White Ral 9002 painted finish. Top in Black or White high pressure phenolic	\$1,195.00
	OXI-20	29 1/8"	31 1/2"	Ø	51 lbs.†	Chair height table with cross shaped central base in painted finish. Round top in high pressure phenolic finish. Adjustable glides. Includes hanging bracket for purse/bags.	Post and base in Black Ral 9004 or Grey White Ral 9002 painted finish. Top in Black or White high pressure phenolic	\$1,335.00
	OXI-30	29 1/8"	27 9/16"	27 9/16"	51 lbs.†	Chair height table with cross shaped central base in painted finish. Square top in high pressure phenolic finish. Adjustable glides. Includes hanging bracket for purse/bags.	Post and base in Black Ral 9004 or Grey White Ral 9002 painted finish. Top in Black or White high pressure phenolic	\$1,255.00
	OXI-40	43 3/8"	23 5/8"	Ø	49 lbs.†	Bar height table with cross shaped central base in painted finish. Round top in high pressure phenolic finish. Adjustable glides. Includes hanging bracket for purse/bags.	Post and base in Black Ral 9004 or Grey White Ral 9002 painted finish. Top in Black or White high pressure phenolic	\$1,195.00
Oxi Bistrot tables are suitable for indoor and outdoor use.								

## STEP

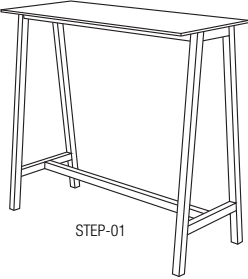
	MODEL	H	W	D	SHIPPING WEIGHT	DESCRIPTION	COLOR/ FINISH	LIST PRICE
	STEP-01	43 1/2"	47 1/4"	19 3/4"	56 lbs.†	High table constructed of co-injected metal frame with techno polymer high pressure phenolic top with black edge band. Painted frame with satin aluminum foot bar.	Top in White, frame/legs in White, Grey or Green	\$995.00
							Tabletop in Black or Pearl Grey, frame/legs in Red, Brown, Orange, Black, Sand or Teal as special order	\$1,095.00
	STEP-02	43 1/2"	47 1/4"	27 3/4"	58 lbs.†	High table constructed of co-injected metal frame with techno polymer high pressure phenolic top with black edge band. Painted frame with satin aluminum foot bar.	Top in White, frame/legs in White, Grey or Green	\$1,075.00
Step tables include 6 hooks on under-side to hold purses/packages. Assembly required. Indoor and outdoor use.								
							Tabletop in Black or Pearl Grey, frame/legs in Red, Brown, Orange, Black, Sand or Teal as special order	\$1,175.00

† Ships via common carrier

## FLOD



FLOD

MODEL	H	W	D	SHIPPING WEIGHT	DESCRIPTION	COLOR/ FINISH	LIST PRICE
FLOD	33 1/16"	14 15/16"	16 5/16"	13 lbs.	Polyethylene barstool with integrated footrest. Indoor and outdoor use – 100% recyclable. Can be provided with plug that allows you to fill unit with pea gravel for outdoor use.	White Ral 9003, Grey Ral 7022, Pistachio Ral 1027, Red Ral 2002, Light Blue Pantone P628U or Brown Pantone P408U	\$520.00
FLO-011					Plug for Flod unit to be used when filling unit with pea gravel. (Must be ordered separately.)		N/C

Flod meets or exceeds the minimum requirements per ANSI/BIFMA X5.1-2011 office chairs.

## CALMA

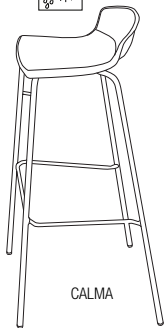

CALMA

MODEL	H	W	D	SHIPPING WEIGHT	DESCRIPTION	COLOR/ FINISH	LIST PRICE
CALMA	30 5/16"	14 1/2"	14 3/16"	44 lbs.†	Stool made of techno polymer seat with painted frame. Stackable 5 high for storage. Suitable for indoor and outdoor use. Assembly required. <b>Sold in cartons of 4 only.</b>	Frame in White, seat in Black, White, Green	\$1,180.00 per carton of 4 (\$295.00 ea.)
						Beige, Red, Dark Blue, Pearl Grey, Orange and Pink as special order.	\$1,300.00 per carton of 4 (\$325.00 ea.)

Calma meets or exceeds the minimum requirements per ANSI/BIFMA X5.1-2011 office chairs.

## RIVISTA



RIVISTA-STL

MODEL	H	W	D	SHIPPING WEIGHT	DESCRIPTION	COLOR/ FINISH	LIST PRICE
RIVISTA-STL	47 11/16"	17 3/4"	17 3/4"	49 lbs.†	Stool made of techno polymer seat with painted frame. Stackable 4 high for storage. Suitable for indoor and outdoor use. Assembly required. <b>Sold in cartons of 4 only.</b>	Frame in White, seat in White with Grey insert, Black with White insert or Caramel with White insert	\$1,380 per carton of 4 (\$345.00 ea.)
						Red with White insert, Turtledove with White insert as special order.	\$1,520.00 per carton of 4 (\$380.00 ea.)

Rivista meets or exceeds the minimum requirements per ANSI/BIFMA X5.1-2011 office chairs.

## ISIDORO

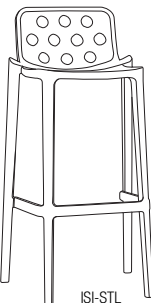

ISI-STL

MODEL	H	W	D	SHIPPING WEIGHT	DESCRIPTION	COLOR/ FINISH	LIST PRICE
ISI-STL	38 3/16"	18 29/32"	18 1/8"	45 lbs.†	Stool made of techno polymer with co-injected metal frame. stackable 6 high for storage. suitable for indoor and outdoor use. <b>Sold in Cartons of 4 only.</b>	White or Light Grey	\$1,060.00 per carton of 4 (\$265.00 ea.)
						Sage Green, Bordeaux, Turtledove, or Grey	\$1,140.00 per carton of 4 (\$285.00 ea.)

Isidoro meets or exceeds the minimum requirements per ANSI/BIFMA X5.1-2011 office chairs.

† Ships via common carrier

## LUCIDO

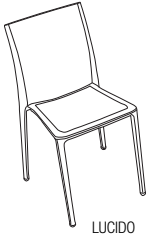

LUCIDO

MODEL	H	W	D	SHIPPING WEIGHT	DESCRIPTION	COLOR/ FINISH	LIST PRICE
LUCIDO	32 5/16"	18 1/4"	19 11/16"	42 lbs.†	Techno polymer chair with co-injected metal frame. Stackable 5 units high. Ships assembled. Suitable for indoor and outdoor use. <b>Sold in Cartons of 4 only.</b>	White, Dark Grey and Teal	\$900.00 per carton of 4 (\$225.00 ea.)
						Beige, Red, Dark Blue, Black, Dark Brown, Pearl Grey, Green, Orange, Mustard, Light Brown or Pink as special order.	\$1,000.00 per carton of 4 (\$250.00 ea.)

Lucido meets or exceeds the minimum requirements per ANSI/BIFMA X5.1-2011 office chairs.

## ISIDORA

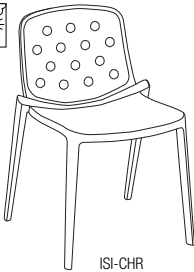

ISI-CHR

MODEL	H	W	D	SHIPPING WEIGHT	DESCRIPTION	COLOR/ FINISH	LIST PRICE
ISI-CHR	34 1/4"	20 15/32"	20 15/32"	36 lbs.†	Chair made of techno polymer. Stackable 6 high for storage. Suitable for indoor and outdoor use. <b>Sold in cartons of 4 only.</b>	White or Light Grey	\$900.00 per carton of 4 (\$225.00 ea.)
						Sage Green, Turtledove or Sand	\$1,000.00 per carton of 4 (\$250.00 ea.)

## OM BASIC

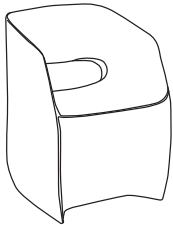

OMB-10

MODEL	H	W	D	SHIPPING WEIGHT	DESCRIPTION	COLOR/ FINISH	LIST PRICE
OMB-10	29 1/2"	22 7/16"	21 1/4"	25 lbs.†	Polyethylene armchair for indoor or outdoor use/100% recyclable. Can be provided with plug that allows you to fill unit with pea gravel for outdoor use.  Seat height is 16 1/2".	White Ral 9003, Gray Ral 7022, Pistachio Ral 1027, Red Ral 2002, Light Blue Pantone P.628 U, Brown Pantone P.408 U	\$695.00
FLO-011				25 lbs.†	Plug for OMB-10 for use when filling OMB-10 with pea gravel. (must be ordered separately.)		N/C

OM Basic meets or exceeds the minimum requirements per ANSI/BIFMA X5.1-2011 office chairs.

## VACANZA

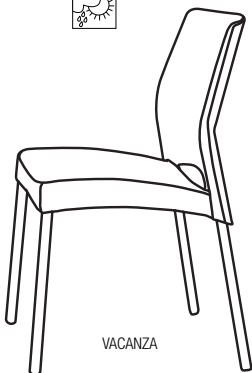

VACANZA

MODEL	H	W	D	SHIPPING WEIGHT	DESCRIPTION	COLOR/ FINISH	LIST PRICE
VACANZA	32"	20 1/4"	22"	38 lbs.†	Polypropylene and fiberglass shell with anodized aluminum frame and UV resistant colors. Chair is provided with cutout for rainwater drain off. Stackable 7 units high for storage. Ships unassembled. Suitable for indoor and outdoor use. <b>Sold in Cartons of 4 only.</b>	Pistachio, White or Black	\$700.00 per carton of 4 (\$175.00 ea.)
						Sky Blue, Sand, Red or Yellow as special order.	\$780.00 per carton of 4 (\$195.00 ea.)

Vacanza meets or exceeds the minimum requirements per ANSI/BIFMA X5.1-2011 office chairs.

† Ships via common carrier

## STILLA

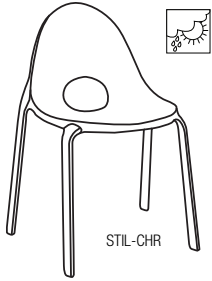

MODEL	H	W	D	SHIPPING WEIGHT	DESCRIPTION	COLOR/ FINISH	LIST PRICE
STIL-CHR	30 3/4"	21"	20 1/4"	36 lbs. †	Polypropylene and fiberglass chair with cutout for rain-water drainoff. Stackable 6 units high for storage. Ships assembled. Suitable for indoor and outdoor use. <b>Sold in Cartons of 4 only.</b>	White, Sand or Red  Orange, Green, Yellow, Viola and Capri Blue as special order.	\$780.00 per carton of 4 (\$195.00 ea.)  \$860.00 per carton of 4 (\$215.00 ea.)

Stilla meets or exceeds the minimum requirements per ANSI/BIFMA X5.1-2011 office chairs.

## RIVISTA

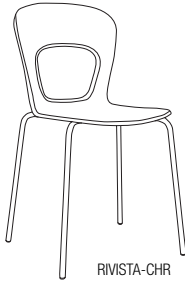

MODEL	H	W	D	SHIPPING WEIGHT	DESCRIPTION	COLOR/ FINISH	LIST PRICE
RIVISTA-CHR	31 29/32"	16 15/16"	19 11/16"	44 lbs. †	Chair made of techno polymer seat with painted frame. Stackable 5 high for storage. Suitable for indoor and outdoor use. <b>Sold in Cartons of 4 only.</b>	Frame in White, seat in white with Grey insert, Black with White insert or Caramel with White insert.  Frame in White, seat in Red with White insert or Turtle Dove with White insert. Available as special order.	\$1,066.00 per carton of 4 (\$265.00 ea.)  \$1,140.00 per carton of 4 (\$285.00 ea.)

Rivista meets or exceeds the minimum requirements per ANSI/BIFMH 5.1-2011 office chairs.

## STILLA

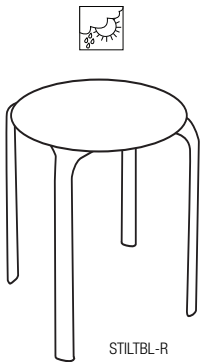

MODEL	H	W	D	SHIPPING WEIGHT	DESCRIPTION	COLOR/ FINISH	LIST PRICE
STILTBL-R	28 5/16"	32 1/2"	Ø	29 lbs. †	Fiberglass filled polypropylene table with round top and 4 legs with rubber feet. Six tables can be stacked vertically for storage. Ships unassembled. Suitable for indoor and outdoor use.	White or Light Grey Sand as special order	\$560.00 \$615.00
STILTBL-S	28 7/16"	28 3/4"	28 3/4"	29 lbs. †	Fiberglass filled polypropylene table with square top and 4 legs with rubber feet. Six tables can be stacked vertically for storage. Ships unassembled. Suitable for indoor and outdoor use.	White or Light Grey Sand as special order	\$595.00 \$655.00

## STEP

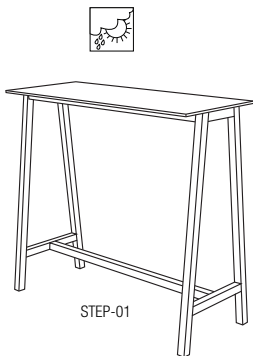

MODEL	H	W	D	SHIPPING WEIGHT	DESCRIPTION	COLOR/ FINISH	LIST PRICE
STEP-01	43 1/2"	47 1/4"	19 3/4"	56 lbs. †	High table constructed of co-injected metal frame with techno polymer high pressure phenolic top with black edge band. Painted frame with satin aluminum foot bar.	Top in White, frame/legs in White, Grey or Green  Tabletop in Black or Pearl Grey, frame/legs in Red, Brown, Orange, Black, Sand or Teal as special order	\$995.00 \$1,095.00
STEP-02	43 1/2"	47 1/4"	27 3/4"	58 lbs. †	High table constructed of co-injected metal frame with techno polymer high pressure phenolic top with black edge band. Painted frame with satin aluminum foot bar.	Top in White, frame/legs in White, Grey or Green  Tabletop in Black or Pearl Grey, frame/legs in Red, Brown, Orange, Black, Sand or Teal as special order	\$1,075.00 \$1,175.00

Step tables include 6 hooks on under-side to hold purses/packages. Assembly required. Indoor and outdoor use.

† Ships via common carrier



## CELES

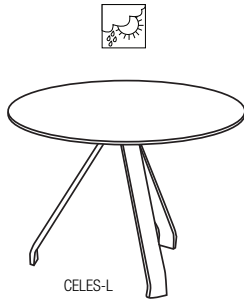

MODEL	H	W	D	SHIPPING WEIGHT	DESCRIPTION	COLOR/ FINISH	LIST PRICE
CELES-L	15 5/8"	19 1/2"	18 3/4"	14 lbs.	Side table constructed of painted aluminum for indoor and outdoor use.	Grey Beige Ral 1019, Mustard Ral 1012, Black Ral 9011 or White Ral 9010 finish	\$1,395.00
CELES-M	13 5/8"	19 1/2"	18 3/4"	13 lbs.	Side table constructed of painted aluminum for indoor and outdoor use.	Grey Beige Ral 1019, Mustard Ral 1012, Black Ral 9011 or White Ral 9010 finish	\$1,375.00
CELES-S	11 11/16"	19 1/2"	18 3/4"	13 lbs.	Side table constructed of painted aluminum for indoor and outdoor use.	Grey Beige Ral 1019, Mustard Ral 1012, Black Ral 9011 or White Ral 9010 finish	\$1,360.00

## OXI BISTROT



MODEL	H	W	D	SHIPPING WEIGHT	DESCRIPTION	COLOR/ FINISH	LIST PRICE
OXI-10	29 1/8"	23 5/8"	Ø	38 lbs.†	Chair height table with cross shaped central base in painted finish. Round top in high pressure phenolic finish. Adjustable glides. Includes hanging bracket for purse/bags.	Post and base in Black Ral 9004 or Grey White Ral 9002 painted finish. Top in Black or White high pressure phenolic	\$1,195.00
OXI-20	29 1/8"	31 1/2"	Ø	51 lbs.†	Chair height table with cross shaped central base in painted finish. Round top in high pressure phenolic finish. Adjustable glides. Includes hanging bracket for purse/bags.	Post and base in Black Ral 9004 or Grey White Ral 9002 painted finish. Top in Black or White high pressure phenolic	\$1,335.00
OXI-30	29 1/8"	27 9/16"	27 9/16"	51 lbs.†	Chair height table with cross shaped central base in painted finish. Square top in high pressure phenolic finish. Adjustable glides. Includes hanging bracket for purse/bags.	Post and base in Black Ral 9004 or Grey White Ral 9002 painted finish. Top in Black or White high pressure phenolic	\$1,255.00
OXI-40	43 3/8"	23 5/8"	Ø	49 lbs.†	Bar height table with cross shaped central base in painted finish. Round top in high pressure phenolic finish. Adjustable glides. Includes hanging bracket for purse/bags.	Post and base in Black Ral 9004 or Grey White Ral 9002 painted finish. *Top in Black or White high pressure phenolic	\$1,195.00

Oxi Bistrot tables are suitable for indoor and outdoor use.

† Ships via common carrier

## FUM



FUM

MODEL	H	W	D	SHIPPING WEIGHT	DESCRIPTION	COLOR/ FINISH	LIST PRICE
FUM	39 11/16"	9 5/8"	9 5/8"	13 lbs.	Standing ashtray. Can be secured to the ground.	White Ral 9010 or Black Ral 9011	\$895.00

Suitable for outdoor use.

## RIGA

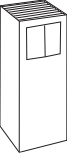

RIGA-ASH

MODEL	H	W	D	SHIPPING WEIGHT	DESCRIPTION	COLOR/ FINISH	LIST PRICE
RIGA-ASH	27 15/16"	9 13/16"	9 13/16"	15 lbs.†	Waste bin with front opening, integrated bag ring and ashtray. Capacity 7.9 gallons.	Stainless Steel with Satin Silver Aluminum top.	\$720.00
RIGA-ASH-P	27 15/16"	9 13/16"	9 13/16"	15 lbs.†	Waste bin with front opening, integrated bag ring and ashtray. Capacity 7.9 gallons.	Grey White Ral 9002 painted body with Satin Silver Aluminum top	\$445.00

Riga Stainless Steel units are suitable for outdoor use under cover. Painted units are for indoor use only.

See page 36 & 37 for matching waste receptacles and page 123 for umbrella stand.

## SMOKE



SMOKE

MODEL	H	W	D	SHIPPING WEIGHT	DESCRIPTION	COLOR/ FINISH	LIST PRICE
SMOKE	35 7/16"	9 13/16"	5 7/8"	29 lbs.†	Locking waste bin with ashtray. Secures to the ground. Capacity 5.8 gallons	Textured Bronze	\$625.00

Suitable for outdoor use.

## VESUVIO

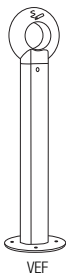

VEF

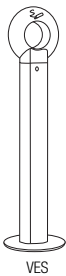

VES

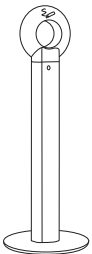

VESR

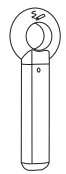

VEM

MODEL	H	W	D	SHIPPING WEIGHT	DESCRIPTION	COLOR/ FINISH	LIST PRICE
VEF	44 5/16"	9 13/16"	7 11/16"	28 lbs.†	Ground /floor fixed ashtray	Black or Silver	\$835.00
VEF-C	44 5/16"	9 13/16"	7 11/16"	28 lbs.†	Ground /floor fixed ashtray	Chrome top/Black or Silver column	\$1,150.00
VES	44 5/16"	9 13/16"	12"	28 lbs.†	Standing ashtray	Black or Silver	\$940.00
VES-C	44 5/16"	9 13/16"	12"	28 lbs.†	Standing ashtray	Chrome top/Black or Silver column	\$1,255.00
VESR	44 5/16"	15 3/4"	15 3/4"	43 lbs.†	Standing ashtray with large base	Black or Silver	\$965.00
VESR-C	44 5/16"	15 3/4"	15 3/4"	43 lbs.†	Standing ashtray with large base	Chrome top/Black or Silver column	\$1,255.00
VEM	29 1/8"	9 13/16"	4 5/16"	15 lbs.	Wall mounted ashtray	Black or Silver	\$730.00
VEM-C	29 1/8"	9 13/16"	4 5/16"	15 lbs.	Wall mounted ashtray	Chrome top/Black or Silver column	\$1,045.00

Suitable for outdoor use.

†Ships via common carrier

## STILLY

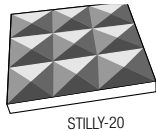
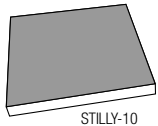

MODEL	H	W	D	SHIPPING WEIGHT	DESCRIPTION	COLOR/FINISH	LIST PRICE
STILLY -10	17 3/8"	17 3/8"	1 9/16"	7 lbs.	Acoustic fabric panel in solid color and flat texture. <b>Sold in cartons of 4 only.</b>	White frame with fabric in Grey, Ivory, Dove Grey, Red, Orange, Blue, Green.	\$660.00 per carton of 4 (\$165.00 ea.)
STILLY -20	17 3/8"	17 3/8"	2 1/8"	7 lbs.	Acoustic fabric panel in solid color with raised pyramid texture. <b>Sold in cartons of 4 only.</b>	White frame with fabric in Grey, Ivory, Dove Grey, Red, Orange, Blue, Green.	\$660.00 per carton of 4 (\$165.00 ea.)

Stilly fabric has been certified to meet the requirements for CAL 117.

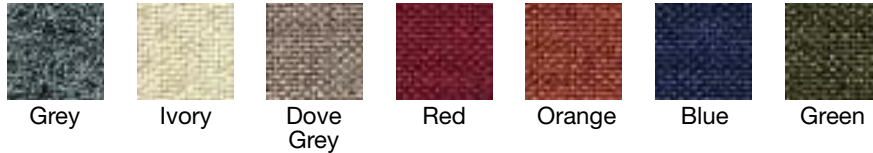

## COMPACT SOISTES

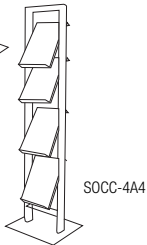
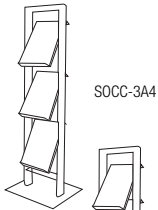

MODEL	H	W	D	SHIPPING WEIGHT	DESCRIPTION	COLOR/FINISH	LIST PRICE
SOCC-3A4	44 7/8"	11 13/16"	13 3/4"	45 lbs. †	Free standing literature display with three shelves that are height adjustable on frame. Shelves can be set horizontally or at 30, 60 or 90 degrees.	Silver Anodized Aluminum frame. Silver painted base, polycarbonate shelves.	\$785.00
SOCC-4A4	68 11/16"	11 13/16"	13 3/4"	60 lbs. †	Free standing literature display with four shelves that are height adjustable on frame. Shelves can be set horizontally or at 30, 60 or 90 degrees.	Silver Anodized Aluminum frame. Silver painted base, polycarbonate shelves.	\$925.00

## FLIP

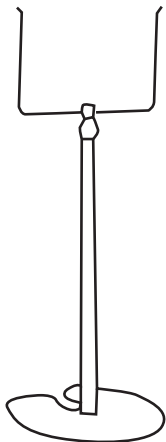

FLP-STQ  
FFLP-STU  
FLP-STB

MODEL	H	W	D	SHIPPING WEIGHT	DESCRIPTION	COLOR/FINISH	LIST PRICE
FLP-STQ	44 3/16"	9 5/8"	11"	9 lbs.	Free standing poster display with telescoping post and magnetic close. Double sided for 8 1/2" x 11" graphics. Post is height adjustable from 24 13/16" to 40 3/16". Folds for storage.	Silver base and post with glass green acrylic	\$755.00
FLP-STU	42"	9 5/8"	11"	11 lbs.	Free standing poster display with telescoping post. Display is at 45 degree angle. Holds 8 1/2" x 11" graphic. Post is height adjustable from 24 13/16" to 40 3/16". Folds for storage.	Silver base and post with glass green acrylic	\$785.00
FLP-STB	43"	9 5/8"	11"	11 lbs.	Free standing brochure holder with telescoping post. Brochure display is at 20 degree angle. Holds approx. 200 single 8 1/2" x 11" sheets. Post is height adjustable from 24 3/16" to 40 3/16". Folds for storage.	Silver base and post with glass green acrylic	\$835.00

†Ships via common carrier

DACAPO

MODEL	H	W	D	SHIPPING WEIGHT	DESCRIPTION	COLOR/ FINISH	LIST PRICE
DC50-2A4	10 1/2"	19 11/16"	5 1/2"	3 lbs.	Wall mounted rail with two 8 1/4" w x 11 11/16" h polystyrene brochure holders.	Silver Anodized Aluminum rail with clear pockets	\$145.00
DC50-3A5	7 7/8"	19 11/16"	4 3/8"	3 lbs.	Wall mounted rail with three 5 13/16" w x 8 1/4" h polystyrene leaflet holders.	Silver Anodized Aluminum rail with clear pockets	\$185.00
DC50-4A6	5 1/4"	19 11/16"	3 1/4"	2 lbs.	Wall mounted rail with four 4 1/8" w x 5 13/16" h polystyrene leaflet holders.	Silver Anodized Aluminum rail with clear pockets	\$190.00
DC10-4A4	10 1/2"	39 3/8"	5 1/2"	5 lbs.	Wall mounted rail with four 8 1/4" w x 11 11/16" h polystyrene leaflet holders.	Silver Anodized Aluminum rail with clear pockets	\$280.00
DC10-6A5	7 7/8"	39 3/8"	4 3/8"	5 lbs.	Wall mounted rail with six 5 13/16" w x 8 1/4" h polystyrene leaflet holders.	Silver Anodized Aluminum rail with clear pockets	\$350.00
DC10-9A6	5 1/4"	39 3/8"	3 1/4"	4 lbs.	Wall mounted rail with nine 4 1/8" w x 5 13/16" h polystyrene leaflet holders.	Silver Anodized Aluminum rail with clear pockets	\$395.00
DC15-7A4	10 1/2"	59 1/16"	5 1/2"	9 lbs.	Wall mounted rail with seven 8 1/4" w x 11 11/16" h polystyrene leaflet holders.	Silver Anodized Aluminum rail with clear pockets	\$465.00
DC15-10A5	7 7/8"	59 1/16"	4 3/8"	8 lbs.	Wall mounted rail with ten 5 13/16" w x 8 1/4" h polystyrene leaflet holders.	Silver Anodized Aluminum rail with clear pockets	\$565.00
DC15-14A6	5 1/4"	59 1/16"	3 1/4"	6 lbs.	Wall mounted rail with fourteen 4 1/8" w x 5 13/16" h polystyrene leaflet holders.	Silver Anodized Aluminum rail with clear pockets	\$610.00
DC20-8A4*	10 1/2"	78 3/4"	5 1/2"	12 lbs.	Wall mounted rail with eight 8 1/4" w x 11 11/16" h polystyrene leaflet holders.	Silver Anodized Aluminum rail with clear pockets	\$605.00
DC20-13A5*	7 7/8"	78 3/4"	4 3/8"	20 lbs.	Wall mounted rail with thirteen 5 13/16" w x 8 1/4" h polystyrene leaflet holders.	Silver Anodized Aluminum rail with clear pockets	\$745.00
DC20-18A6*	5 1/4"	78 3/4"	3 1/4"	12 lbs.	Wall mounted rail with eighteen 4 1/8" w x 5 13/16" h polystyrene leaflet holders.	Silver Anodized Aluminum rail with clear pockets	\$795.00

\*Rail in 2 sections.

**Choose from above finished models, or purchase components below to customize according to your requirements.**

DCR-500	19 11/16"			2 lbs.	Wall mounted rail only 19 11/16" long	Silver Anodized Aluminum	\$42.00
DCR-1000	39 3/8"			3 lbs.	Wall mounted rail only 39 3/8" long	Silver Anodized Aluminum	\$68.00
DCR-1500	59 1/16"			4 lbs.	Wall mounted rail only 59 1/16" long	Silver Anodized Aluminum	\$95.00
DCR-2000*	78 3/4"			6 lbs.	Wall mounted rail only 78 3/4" long *Rail in 2 sections.	Silver Anodized Aluminum	\$158.00
DCT-A6	5 7/8"	4 5/8"	2 1/2"	1/2 lb.	Polystyrene leaflet holder for 4 1/8" x 5 13/16" leaflets. Pocket is 1 5/8" deep.	Clear Polystyrene	\$37.00
DCT-A5	8"	6 1/2"	2 5/8"	1/2 lb.	Polystyrene leaflet holder for 5 13/16" x 8 1/4" leaflets. Pocket is 1 5/8" deep.	Clear Polystyrene	\$47.00
DCT-A4	11 3/16"	9 1/4"	3"	1/2 lb.	Polystyrene leaflet holder for 8 1/4" x 11 11/16" brochures. Pocket is 1 5/8" deep.	Clear Polystyrene	\$58.00



DC50-4A6

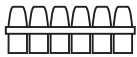

DC10-6A5

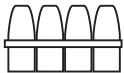

DC10-4A4



DCR-500

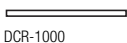

DCR-1000

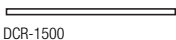

DCR-1500



DCR-2000

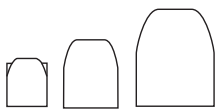

A6

A5

A4

## DACAPO I POINT

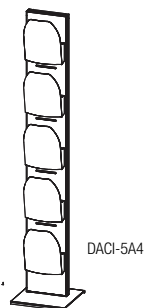
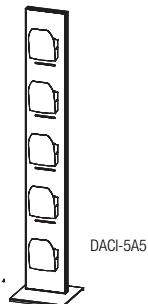
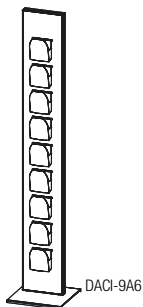

MODEL	H	W	D	SHIPPING WEIGHT	DESCRIPTION	COLOR/ FINISH	LIST PRICE
DACI-5A4	68 1/8"	13 1/16"	13 1/16"	40 lbs.†	Free standing single sided brochure display with five polystyrene holders for brochures that are 8 1/4" w x 11 11/16" h.	Black display with Silver frame and clear pockets	\$1,095.00
DACI-10A4	68 1/8"	13 1/16"	13 1/16"	47 lbs.†	Free standing double sided brochure display with ten polystyrene holders for brochures that are 8 1/4" w x 11 11/16" h.	Black display with Silver frame and clear pockets	\$1,380.00
DACI-5A5	68 1/8"	13 1/16"	13 1/16"	39 lbs.†	Free standing single sided leaflet display with five polystyrene holders for leaflets that are 5 13/16" w x 8 1/4" h.	Black display with Silver frame and clear pockets	\$1,040.00
DACI-10A5	68 1/8"	13 1/16"	13 1/16"	43 lbs.†	Free standing double sided leaflet display with ten polystyrene holders for leaflets that are 5 13/16" w x 8 1/4" h.	Black display with Silver frame and clear pockets	\$1,275.00
DACI-9A6	68 1/8"	13 1/16"	13 1/16"	39 lbs.†	Free standing single sided leaflet display with nine polystyrene holders for leaflets that are 4 1/8" w x 5 13/16" h.	Black display with Silver frame and clear pockets	\$1,135.00
DACI-18A6	68 1/8"	13 1/16"	13 1/16"	42 lbs.†	Free standing double sided leaflet display with eighteen polystyrene holders for leaflets that are 4 1/8" w x 5 13/16" h.	Black display with Silver frame and clear pockets	\$1,465.00

**Choose from above finished models, or purchase components below to customize according to your requirements.**

DACI-PR	68 1/8"	13 1/16"	13 1/16"	35 lbs.†	Free standing double sided display with 9 slots on each side.	Black display with Silver frame	\$795.00
DCT-A6	5 7/8"	4 5/8"	2 1/2"	1/2 lb.	Polystyrene leaflet holder for 4 1/8" x 5 13/16" leaflets. Pocket is 1 5/8" deep.	Clear Polystyrene	\$37.00
DCT-A5	8"	6 1/2"	2 5/8"	1/2 lb.	Polystyrene leaflet holder for 5 13/16" x 8 1/4" leaflets. Pocket is 1 5/8" deep.	Clear Polystyrene	\$47.00
DCT-A4	11 3/16"	9 1/4"	3"	1/2 lb.	Polystyrene brochure holder for 8 1/4" x 11 11/16" brochures. Pocket is 1 5/8" deep.	Clear Polystyrene	\$58.00

## SOLID ZIP

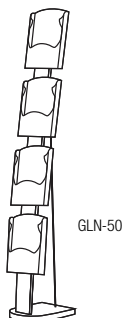

MODEL	H	W	D	SHIPPING WEIGHT	DESCRIPTION	COLOR/ FINISH	LIST PRICE
SOZ165-AL	62 13/16"	9 13/16"	13"	14 lbs.	Free standing brochure holder with four polycarbonate pockets for 8 1/4" w x 11 11/16" h brochures.	Silver Anodized Aluminum profile with clear pockets	\$575.00
DNZIP-02				1 lb.	Set of two acrylic pocket dividers for brochure holder.	Clear Acrylic	\$47.00

† Ships via common carrier

Available with painted or acrylic front pocket.

**MODEL 1010**

One pocket solid wood magazine rack.

**DIMENSIONS**

height: 15" width: 13 1/4"  
depth: 4"

**COLORS**

Black and Sandstone painted finishes

**SOLID WOOD TRIM FINISH**

Victorian Cherry, Walnut, Mahogany, Oak, Natural Maple\* and Black on Oak.

SHIPPING WEIGHT (lbs.) 6

• PRICE \$159.00

**MODEL 1030**

Three pocket solid wood magazine rack.

**DIMENSIONS**

height: 24 1/8" width: 13 1/4"  
depth: 4"

**COLORS**

Black and Sandstone painted finishes

**SOLID WOOD TRIM FINISH**

Victorian Cherry, Walnut, Mahogany, Oak, Natural Maple\* and Black on Oak.

SHIPPING WEIGHT (lbs.) 11

• PRICE \$282.00

**MODEL 1040**

Four pocket solid wood magazine rack.

**DIMENSIONS**

height: 31 5/8" width: 13 1/4"  
depth: 4"

**COLORS**

Black and Sandstone painted finishes

**SOLID WOOD TRIM FINISH**

Victorian Cherry, Walnut, Mahogany, Oak, Natural Maple\* and Black on Oak.

SHIPPING WEIGHT (lbs.) 14

• PRICE \$331.00

**MODEL 1070**

Seven pocket solid wood magazine rack.

**DIMENSIONS**

height: 54 1/8" width: 13 1/4"  
depth: 4"

**COLORS**

Black and Sandstone painted finishes

**SOLID WOOD TRIM FINISH**

Victorian Cherry, Walnut, Mahogany, Oak, Natural Maple\* and Black on Oak.

SHIPPING WEIGHT (lbs.) 23

• PRICE \$511.00

**MODEL 1010A**

With clear acrylic pockets

• PRICE \$185.00

**MODEL 1030A**

With clear acrylic pockets

• PRICE \$329.00

**MODEL 1040A**

With clear acrylic pockets

• PRICE \$408.00

**MODEL 1070A**

With clear acrylic pockets

• PRICE \$656.00

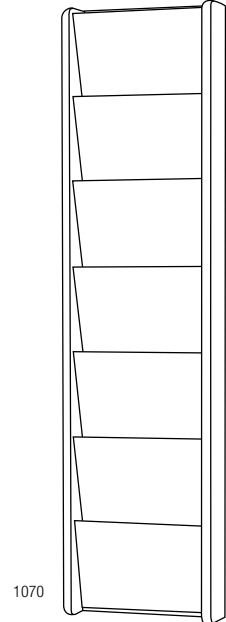
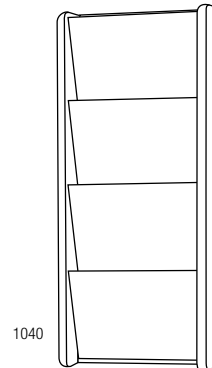
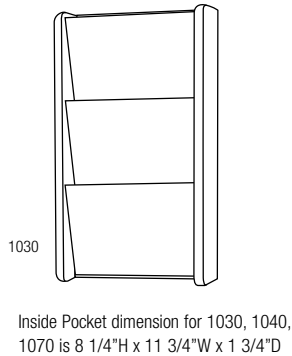
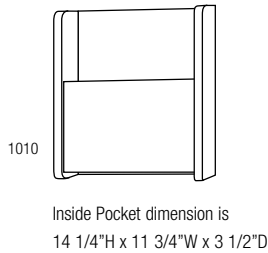

**SERIES 1000: HOW TO ORDER**

1. Choose painted or acrylic front pocket
2. Choose your model and quantity
3. Choose your color
4. Choose your wood trim finish

**Example:**

1 Model 1030A  
Black  
Oak Side Panels  
With clear acrylic pockets

**SERIES 1000  
POCKET DIVIDER**

Acrylic divider for use with 1000 series Mag Raks™.

1010 DIVIDER \$35.00

1030, 1040

1070 DIVIDER \$23.00

\*Wood graining will have some variation.

## 2000 SERIES

### MODEL 2010

One pocket metal magazine rack.

#### DIMENSIONS

height: 12 3/8" width: 9 3/4"  
depth: 2"

#### SHELL COLORS

Black and  
Sandstone painted finishes

SHIPPING WEIGHT (lbs.) 3

PRICE \$110.00

#### OPTIONAL WOOD TRIM

Victorian Cherry, Walnut, Mahogany, Oak,  
Natural Maple\* and Black on Oak.

#### SIDE PANELS (pair)

SHIPPING WEIGHT (lbs.) 1

PRICE \$37.00

#### ADD-ON CENTER PANELS

SHIPPING WEIGHT (lbs.) 1

PRICE \$40.00

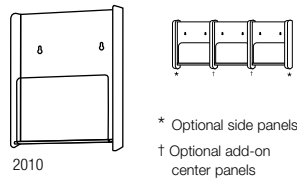

### MODEL 2020

Two pocket metal magazine rack.

#### DIMENSIONS

height: 24 3/4" width: 9 3/4"  
depth: 2"

#### SHELL COLORS

Black and  
Sandstone painted finishes

SHIPPING WEIGHT (lbs.) 5

• PRICE \$195.00

#### OPTIONAL WOOD TRIM

Victorian Cherry, Walnut, Mahogany, Oak,  
Natural Maple\* and Black on Oak.

#### SIDE PANELS (pair)

SHIPPING WEIGHT (lbs.) 2

• PRICE \$88.00

#### ADD-ON CENTER PANELS

SHIPPING WEIGHT (lbs.) 1

• PRICE \$51.00

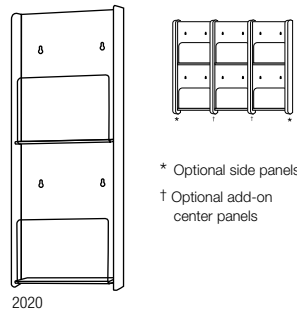

### MODEL 2030

Three pocket metal magazine rack.

#### DIMENSIONS

height: 37 1/8" width: 9 3/4"  
depth: 2"

#### SHELL COLORS

Black and  
Sandstone painted finishes

SHIPPING WEIGHT (lbs.) 7

• PRICE \$270.00

#### OPTIONAL WOOD TRIM

Victorian Cherry, Walnut, Mahogany, Oak,  
Natural Maple\* and Black on Oak.

#### SIDE PANELS (pair)

SHIPPING WEIGHT (lbs.) 3

• PRICE \$109.00

#### ADD-ON CENTER PANELS

SHIPPING WEIGHT (lbs.) 1

• PRICE \$75.00

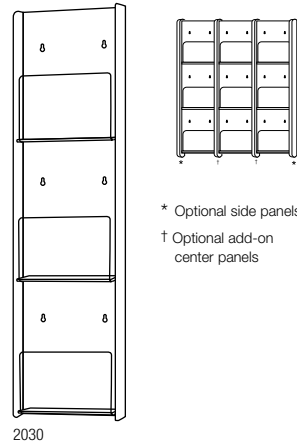

### MODEL 2040

Four pocket metal magazine rack.

#### DIMENSIONS

height: 49 1/2" width: 9 3/4"  
depth: 2"

#### SHELL COLORS

Black and  
Sandstone painted finishes

SHIPPING WEIGHT (lbs.) 9

• PRICE \$359.00

#### OPTIONAL WOOD TRIM

Victorian Cherry, Walnut, Mahogany, Oak,  
Natural Maple\* and Black on Oak.

#### SIDE PANELS (pair)

SHIPPING WEIGHT (lbs.) 4

• PRICE \$151.00

#### ADD-ON CENTER PANELS

SHIPPING WEIGHT (lbs.) 2

• PRICE \$85.00

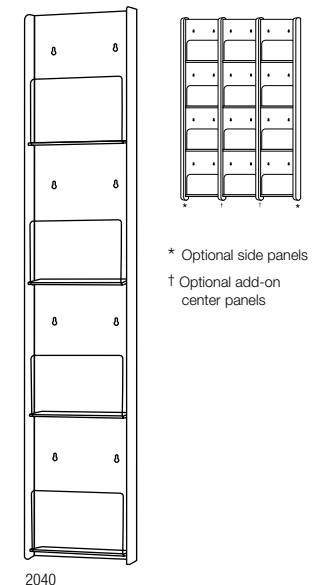

Inside Pocket dimension for 2000 series is  
11 1/2"H x 9 3/4"W x 2"D

**2000 Series can be mounted over a panel. Call for details and pricing.**

### OPTIONAL SOLID WOOD TRIM • SERIES 2000, 2100 AND 2200

\* Solid wood side panels available in six colors. A pair of side panels adds 1 1/8" to the total width and only 5/16" to overall depth.

† Matching solid wood add-on panels allow side-by-side installation of two or more units of the same height. Each panel adds 1/2" to the total width. The example shown (right) consists of 3 model 2020 units (9 3/4" each), 1 pair side panels (9/16" per panel) and 2 add-on panels (1/2" each) which add up to an overall 31 3/8" width.

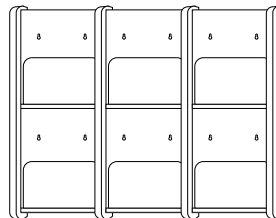

### SERIES 2000: HOW TO ORDER

1. Choose the model
2. Choose the shell color
3. Choose the **optional** trim color
4. Choose the **optional** center add-on†

† Center add-on strips are only necessary if you want to use multiple adjoining Mag Raks. Example: For a display featuring 2) 2010's, order: 2) 2010's, 1) set of side panels and 1) center add-on piece.

EXAMPLE:  
1 Model 2010  
Black Shell  
Oak Side Panels

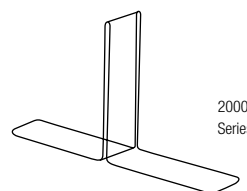

### SERIES 2000 POCKET DIVIDER

Acrylic divider for use with 2000 series Mag Raks™ splits pocket for pamphlet display.

#### DIMENSIONS

height: 5 1/4" width: 9 1/2"  
depth: 2"

SHIPPING WEIGHT (lbs.) 1

• PRICE \$23.00

\*Wood graining will have some variation.

[www.magnusongroup.com](http://www.magnusongroup.com) (Tel.) 800-342-5725 (Fax) 888-329-4729

2000 SERIES / CHART HOLDERS

MODEL 2110

One pocket metal record holder.

DIMENSIONS

height: 10 7/8" width: 13 1/2"  
depth: 2"

SHELL COLORS

**Black** and  
Sandstone painted finishes

SHIPPING WEIGHT (lbs.) 3

• PRICE \$142.00

OPTIONAL WOOD TRIM

Victorian Cherry, Walnut, Mahogany, **Oak**,  
Natural Maple\* and Black on Oak.

SIDE PANELS (pair)

SHIPPING WEIGHT (lbs.) 1

• PRICE \$37.00

ADD-ON CENTER PANELS

SHIPPING WEIGHT (lbs.) 1

• PRICE \$35.00

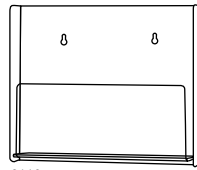

2110

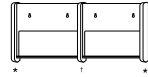

\* Optional side panels  
† Optional add-on center panels

MODEL 2210

One pocket metal record holder.

DIMENSIONS

height: 17 3/8" width: 20"  
depth: 2"

SHELL COLORS

Black and  
Sandstone painted finishes

SHIPPING WEIGHT (lbs.) 6

• PRICE \$168.00

OPTIONAL WOOD TRIM

Victorian Cherry, Walnut, Mahogany, Oak,  
Natural Maple\* and Black on Oak.

SIDE PANELS (pair)

SHIPPING WEIGHT (lbs.) 1

• PRICE \$53.00

ADD-ON CENTER PANELS

SHIPPING WEIGHT (lbs.) 1

• PRICE \$51.00

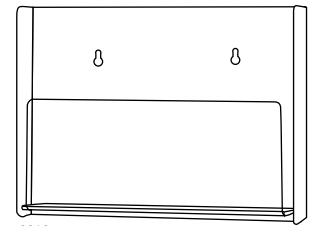

2210

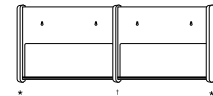

\* Optional side panels  
† Optional add-on center panels

MODEL 2112

HIPPA friendly record holder

DIMENSIONS

height: 11 3/8" width: 14 5/8"  
depth: 2 5/16"

SHELL COLORS

**Black** and  
Sandstone painted finishes

SHIPPING WEIGHT (lbs.) 3

• PRICE \$172.00

OPTIONAL WOOD TRIM

Victorian Cherry, Walnut, Mahogany, **Oak**,  
Natural Maple\* and Black on Oak.

SIDE PANELS (pair)

SHIPPING WEIGHT (lbs.) 1

• PRICE \$37.00

ADD-ON CENTER PANELS

SHIPPING WEIGHT (lbs.) 1

• PRICE \$35.00

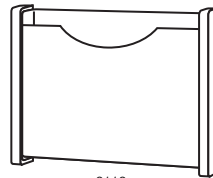

2112  
w/trim

MODEL 2212

HIPPA friendly record holder

DIMENSIONS

height: 17 7/8" width: 21 1/8"  
depth: 2 5/16"

SHELL COLORS

Black and  
Sandstone painted finishes

SHIPPING WEIGHT (lbs.) 6

• PRICE \$292.00

OPTIONAL WOOD TRIM

Victorian Cherry, Walnut, Mahogany, Oak,  
Natural Maple\* and Black on Oak.

SIDE PANELS (pair)

SHIPPING WEIGHT (lbs.) 1

• PRICE \$53.00

ADD-ON CENTER PANELS

SHIPPING WEIGHT (lbs.) 1

• PRICE \$51.00

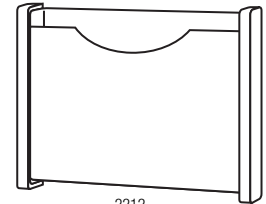

2212  
w/trim

Inside Pocket dimension for 2110 and 2112 is  
10"H x 13 1/2"W x 2"D

Opaque acrylic panel on 2112 and 2212 are full height and width of record holder.

Inside Pocket dimension for 2210 and 2212 is  
16 1/2"H x 20"W x 2"D

2000 Series can be mounted over a panel. Call for details and pricing.

**Bold** denotes quick ship  
See page 7 for details.

\*Wood graining will have some variations.



## RACK SOISTES

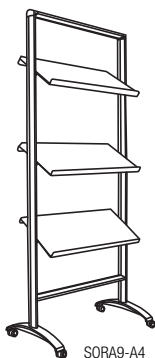

MODEL	H	W	D	SHIPPING WEIGHT	DESCRIPTION	COLOR/ FINISH	LIST PRICE
SORA9-A4	73 5/8"	28 3/4"	16 15/16"	33 lbs. †	Magazine rack with 3 shelves that can be inclined independently in three positions. Each shelf is freely adjustable in height and can hold three magazines that are 8 1/2" x 11" in size. Shelves can be set flat, horizontally or tilted at 30, 60 or 90 degrees. Lip on shelves is 1 3/16". Includes locking casters.	Silver Anodized Aluminum frame, satin acrylic shelves.	\$1,635.00
SORA6-A4	40 9/16"	28 1/4"	16 15/16"	30 lbs. †	Magazine rack with 2 shelves that can be inclined independently in three positions. Each shelf is freely adjustable in height and can hold three magazines that are 8 1/2" x 11" in size. Shelves can be set flat, horizontally or tilted at 30, 60 or 90 degrees. Lip on shelves is 1 3/16". Includes locking casters.	Silver Anodized Aluminum frame, satin acrylic shelves.	\$1,235.00

## CUBIC SOISTES

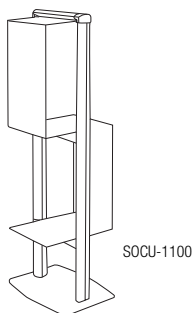

MODEL	H	W	D	SHIPPING WEIGHT	DESCRIPTION	COLOR/ FINISH	LIST PRICE
SOCU-1100	43 5/16"	13"	12 13/16"	30 lbs. †	Catalog or magazine stand with two shelves.	Silver Anodized Aluminum frame, painted Silver shelves and base	\$1,150.00

## WALLMATE SOISTES

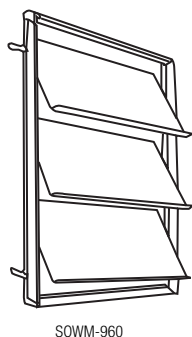

MODEL	H	W	D	SHIPPING WEIGHT	DESCRIPTION	COLOR/ FINISH	LIST PRICE
SOWM-960	37 13/16"	37 13/16"	9 5/8"	25 lbs. †	Wall mounted magazine or catalog display with three shelves that are adjustable in height on frame.	Silver Anodized Aluminum frame, shelves in satin acrylic.	\$1,535.00
SOCF-1515				1 lb.	Set of two brackets for top of WallMate to hold signage up to 1/8" thick.	Silver	\$47.00

†Ships via common carrier

## 7000 SERIES

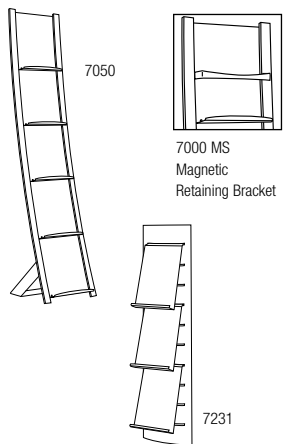

MODEL	H	W	D	SHIPPING WEIGHT	DESCRIPTION	COLOR/ FINISH	LIST PRICE
<b>7050</b>	63 7/16"	13 7/8"	15 1/2"	27 lbs.	Five adjustable shelf textured metal magazine rack	Black or Silver	\$1,045.00
<b>7000 MS</b>	1"	14"	2"	1 lbs.	Magnetic retaining bracket	Black	\$79.00
7231 TORO W	45 5/16"	11 7/16"	7 7/8"	30 lbs.	Wall mounted brochure holder with 3 shelves	Black steel frame w/silver aluminum shelves	\$841.00

## SCOOP

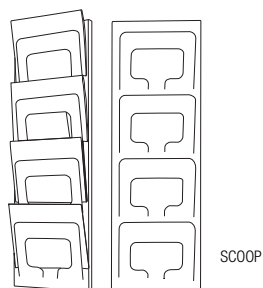

MODEL	H	W	D	SHIPPING WEIGHT	DESCRIPTION	COLOR/ FINISH	LIST PRICE
SCOOP	38 5/8"	12 5/8"	1/8"-2 3/4"	10 lbs.	Wall mounted newspaper/magazine display with four pockets. Painted steel finish. Pockets expand to 2 3/4" to hold varying sized media.	White, Green or Pink	\$340.00

## KOKU

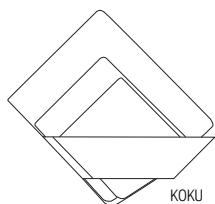

MODEL	H	W	D	SHIPPING WEIGHT	DESCRIPTION	COLOR/ FINISH	LIST PRICE
KOKU	6 3/4"	11 1/16"	2 13/16"	4 lbs.	Painted steel wall mounted book shelf with concealed mounting system.	White Ral 9010, Black Ral 9011, Grey Beige Ral 1019, Mustard Ral 1012	\$330.00

## VOICI

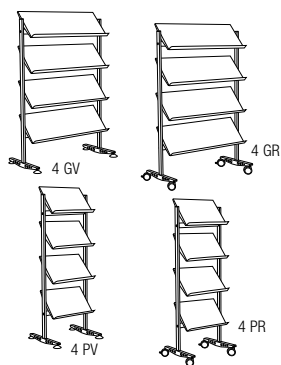

MODEL	H	W	D	SHIPPING WEIGHT	DESCRIPTION	COLOR/ FINISH	LIST PRICE
VOICI 4 GV	59 1/16"	43 15/16"	20 1/4"	54 lbs.†	Large magazine/leaflet display 4 shelves, single sided, on glides	White, Sand, Black, Silver	\$1,885.00
VOICI 4 GR	61 1/16"	43 15/16"	20 1/4"	55 lbs.†	Large magazine/leaflet display 4 shelves, single sided, on casters	White, Sand, Black, Silver	\$1,990.00
VOICI 4 PV	59 1/16"	24 3/16"	20 1/4"	44 lbs.†	Small magazine/leaflet display 4 shelves, single sided, on glides	White, Sand, Black, Silver	\$1,415.00
VOICI 4 PR	61 1/16"	24 3/16"	20 1/4"	45 lbs.†	Small magazine/leaflet display 4 shelves, single sided, on casters	White, Sand, Black, Silver	\$1,495.00

Shelves on Voici are adjustable in three pre-determined positions- horizontal, tilted at 30° or tilted at 45°).

†Ships via common carrier

**Bold** denotes quick ship  
See page 7 for details.

## FLAP

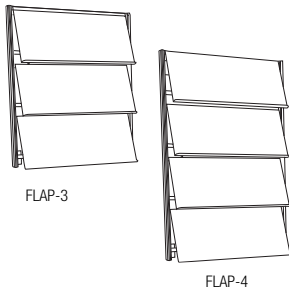

MODEL	H	W	D	SHIPPING WEIGHT	DESCRIPTION	COLOR/ FINISH	LIST PRICE
FLAP-3	35 7/16"	29 1/2"	7 1/16"	28 lbs.†	Wall mounted magazine and literature display with three steel shelves.	Frame is Silver Anodized Aluminum, shelves and base in Black RAL9011, Forged Grey or White Ral 9010	\$1,360.00
FLAP-4	47 1/4"	29 1/2"	7 1/16"	34 lbs.†	Wall mounted magazine and literature display with four steel shelves.	Frame is Silver Anodized Aluminum, shelves and base in Black RAL9011, Forged Grey or White Ral 9010	\$1,675.00

## IFLAG

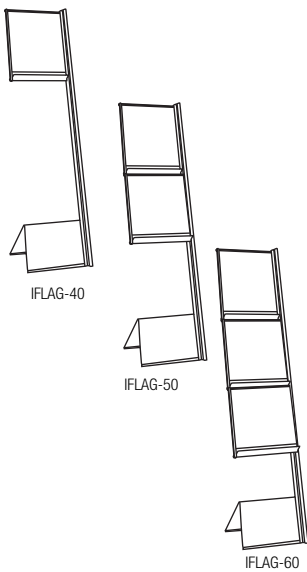

MODEL	H	W	D	SHIPPING WEIGHT	DESCRIPTION	COLOR/ FINISH	LIST PRICE
IFLAG-40	39 3/8"	9 13/16"	17 11/16"	12 lbs.	Transparent methacrylate display featuring a single shelf for brochures that are 8 1/4" x 11 11/16". Single sheet can also be inserted between methacrylate with brochures or papers on the shelf for take away.	Post in Anodized Silver, base in Textured Forged Grey, White Ral 9010 or Textured Black Ral 9011	\$615.00
IFLAG-50	39 3/8"	9 13/16"	17 11/16"	14 lbs.	Transparent methacrylate display featuring two shelves for brochures that are 8 1/4" x 11 11/16". Single sheet can also be inserted between methacrylate with brochures or papers on the shelf or shelves below for take away.	Post in Anodized Silver, base in Textured Forged Grey, White Ral 9010 or Textured Black Ral 9011	\$820.00
IFLAG-60	50 13/16"	9 13/16"	17 11/16"	19 lbs.	Transparent methacrylate display featuring three shelves for brochures that are 8 1/4" x 11 11/16". Single sheet can also be inserted between methacrylate with brochures or papers on the shelf or shelves for take away.	Post in Anodized Silver, base in Textured Forged Grey, White Ral 9010 or Textured Black Ral 9011	\$1,065.00

## USIO

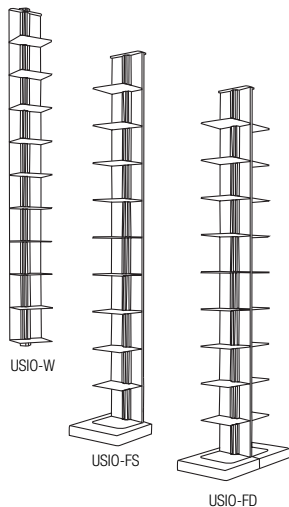

MODEL	H	W	D	SHIPPING WEIGHT	DESCRIPTION	COLOR/ FINISH	LIST PRICE
USIO-W	64 1/2"	6 1/4"	6 1/8"	21 lbs.	Wall mounted bookshelf with aluminum center column with 10 painted steel fixed height shelves.	Anodized Silver Matt column, shelves in Forge Grey, White Ral 9010, Black Ral 9011	\$665.00
USIO-FS	64 9/16"	9 3/4"	9 7/8"	35 lbs.†	Floor standing single sided bookshelf with aluminum center column with 10 painted steel fixed height shelves.	Anodized Silver Matt column, shelves in Forge Grey, White Ral 9010, Black Ral 9011	\$1,045.00
USIO-FD	64 9/16"	9 3/4"	19 3/4"	57 lbs.†	Floor standing double sided bookshelf with aluminum center column with 20 painted steel fixed height shelves.	Anodized Silver Matt column, shelves in Forge Grey, White Ral 9010, Black Ral 9011	\$1,570.00

All Usio shelves are 6 1/8" apart.

†Ships via common carrier

## ZIN

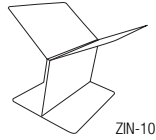

ZIN-10

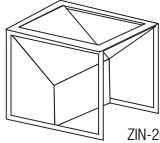

ZIN-20, 30

MODEL	H	W	D	SHIPPING WEIGHT	DESCRIPTION	COLOR/ FINISH	LIST PRICE
ZIN-10	14 9/16"	17 1/16"	15 3/4"	19 lbs.	Magazine rack in textured painted steel.	White, Black or Forge Grey	\$560.00
ZIN-20	15 7/8"	15 3/4"	15 9/16"	7 lbs.	Magazine rack with painted steel frame and Light Grey screen fabric.	Black Ral 9011 or White Ral 9010 Frame	\$760.00
ZIN-30	15 7/8"	15 3/4"	15 9/16"	7 lbs.	Magazine rack with Chrome steel frame and Light Grey screen fabric.	Chrome frame	\$865.00

## COMPACT SOISTES

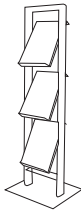

SOCC-3A4

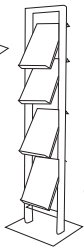

SOCC-4A4

MODEL	H	W	D	SHIPPING WEIGHT	DESCRIPTION	COLOR/ FINISH	LIST PRICE
SOCC-3A4	44 7/8"	11 13/16"	13 3/4"	45 lbs. †	Free standing literature display with three shelves that are height adjustable on frame. Shelves can be set horizontally or at 30, 60 or 90 degrees.	Silver Anodized Aluminum frame. Silver painted base, polycarbonate shelves.	\$785.00
SOCC-4A4	68 11/16"	11 13/16"	13 3/4"	60 lbs. †	Free standing literature display with four shelves that are height adjustable on frame. Shelves can be set horizontally or at 30, 60 or 90 degrees.	Silver Anodized Aluminum frame. Silver painted base, polycarbonate shelves.	\$925.00

## FLIP

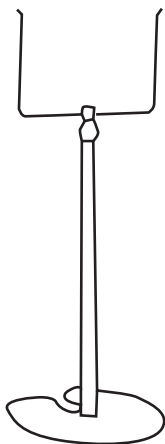

FLP-STQ  
FFLP-STU  
FLP-STB

MODEL	H	W	D	SHIPPING WEIGHT	DESCRIPTION	COLOR/ FINISH	LIST PRICE
FLP-STQ	44 3/16"	9 5/8"	11"	9 lbs.	Free standing poster display with telescoping post and magnetic close. Double sided for 8 1/2" x 11" graphics. Post is height adjustable from 24 13/16" to 40 3/16". Folds for storage.	Silver base and post with glass green acrylic	\$755.00
FLP-STU	42"	9 5/8"	11"	11 lbs.	Free standing poster display with telescoping post. Display is at 45 degree angle. Holds 8 1/2" x 11" graphic. Post is height adjustable from 24 13/16" to 40 3/16". Folds for storage.	Silver base and post with glass green acrylic	\$785.00
FLP-STB	43"	9 5/8"	11"	11 lbs.	Free standing brochure holder with telescoping post. Brochure display is at 20 degree angle. Holds approx. 200 single 8 1/2" x 11" sheets. Post is height adjustable from 24 3/16" to 40 3/16". Folds for storage.	Silver base and post with glass green acrylic	\$835.00

†Ships via common carrier

## PANTALLA



PANTALLA-S

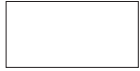

PANTALLA-M



PANTALLA-L



PANTALLA-FLR

MODEL	H	W	D	SHIPPING WEIGHT	DESCRIPTION	COLOR/ FINISH	LIST PRICE
PANTALLA-S	17 5/16"	17 5/16"	3/16"	7 lbs.	Magnetic notice panel for various media. Units can be used individually or grouped together to create an original wall composition.	White Ral 9010, Black Ral 9011, Satin Grey Beige Ral 1019, or Satin Mustard Ral 1012	\$295.00
PANTALLA-M	17 5/16"	34 5/8"	3/16"	14 lbs.	Magnetic notice panel for various media. Units can be used individually or grouped together to create an original wall composition.	White Ral 9010, Black Ral 9011, Satin Grey Beige Ral 1019, or Satin Mustard Ral 1012	\$485.00
PANTALLA-L	17 5/16"	51 15/16"	3/16"	23 lbs.	Magnetic notice panel for various media. Units can be used individually or grouped together to create an original wall composition.	White Ral 9010, Black Ral 9011, Satin Grey Beige Ral 1019, or Satin Mustard Ral 1012	\$720.00
PANTALLA-FLR	71 11/16"	17 3/4"	18 1/8"	67 lbs.†	Free standing vertical magnetic notice panel for various media that can also function as a room divider. Units can be used individually or grouped together.	White Ral 9010, Black Ral 9011	\$1,885.00

White magnets in assorted sizes are included.

S unit includes 4, M unit includes 6, L unit includes 8 and FLR units include 10.

## SNAPREX

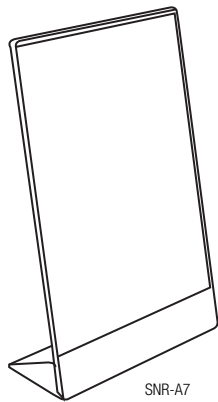

SNR-A7  
SNR-A6  
SNR-A4  
SNR-A3

MODEL	H	W	D	SHIPPING WEIGHT	DESCRIPTION	COLOR/ FINISH	LIST PRICE
SNR-A7	5 11/16"	2 15/16"	1 5/8"	1 lb.	Tabletop display including base with acrylic graphic holder. Use vertically or horizontally. Holds graphic that is 4 1/8" x 2 29/32".	Brushed Stainless Steel base with acrylic	\$58.00
SNR-A6	7 9/16"	4 1/8"	1 5/8"	1 lb.	Tabletop display including base with acrylic graphic holder. Use vertically or horizontally. Holds graphic that is 5 13/16" x 4 1/8".	Brushed Stainless Steel base with acrylic	\$68.00
SNR-A5	10"	5 13/16"	1 15/16"	1 lb.	Tabletop display including base with acrylic graphic holder. Use vertically or horizontally. Holds graphic that is 8 3/4" x 5 13/16".	Brushed Stainless Steel base with acrylic	\$84.00
SNR-A4	13 7/16"	8 3/4"	2 13/16"	2 lbs.	Tabletop display including base with acrylic graphic holder. Use vertically or horizontally. Holds graphic that is 11 11/16" x 8 3/4".	Brushed Stainless Steel base with acrylic	\$120.00
SNR-A3	18 1/2"	11 11/16"	4"	3 lbs.	Tabletop display including base with acrylic graphic holder. Use vertically or horizontally. Holds graphic that is 16 1/2" x 11 11/16".	Brushed Stainless Steel base with acrylic	\$195.00

† Ships via common carrier

## CLAMPER

MODEL	H	W	D	SHIPPING WEIGHT	DESCRIPTION	COLOR/ FINISH	LIST PRICE
FCL-10	6"	5 13/16"	1 3/8"	2 lbs.	Graphic display holder constructed of two pieces of tempered glass and single Silver Anodized Aluminum clamp. Holds media 5 13/16" x 5 13/16".	Tempered Glass with one Silver Anodized Aluminum clamp 3 15/16" L	\$155.00
FCL-20	6"	11 11/16"	1 3/8"	3 lbs.	Graphic display holder constructed of two pieces of tempered glass and single Silver Anodized Aluminum clamp. Holds media 5 13/16" x 11 11/16".	Tempered Glass with one Silver Anodized Aluminum clamp 7 7/8" L	\$240.00
FCL-30	6 9/16"	11 11/16"	1 3/8"	3 lbs.	Graphic display holder constructed of two pieces of tempered glass and two Silver Anodized Aluminum clamps. Holds media 5 13/16" x 11 11/16".	Tempered Glass with two Silver Anodized Aluminum clamps 3 15/16" L	\$280.00
FCL-40	12 7/16"	16 1/2"	1 3/8"	8 lbs.	Graphic display holder constructed of two pieces of tempered glass and two Silver Anodized Aluminum clamps. Holds media 11 11/16" x 16 1/2".	Tempered Glass with two Silver Anodized Aluminum clamps 11 13/16" L	\$540.00
FCL-50	12 7/16"	16 1/2"	1 3/8"	7 lbs.	Graphic display holder constructed of two pieces of tempered glass and two Silver Anodized Aluminum clamps. Holds media 11 11/16" x 16 1/2".	Tempered Glass with two Silver Anodized Aluminum clamps 7 7/8" L	\$470.00
FCL-60	17 1/4"	23 3/8"	1 3/8"	14 lbs.	Graphic display holder constructed of two pieces of tempered glass and two Silver Anodized Aluminum clamps. Holds media 16 1/2" x 23 3/8".	Tempered Glass with two Silver Anodized Aluminum clamps 15 3/4" L	\$740.00
FCL-70	17 1/4"	23 3/8"	1 3/8"	14 lbs.	Graphic display holder constructed of two pieces of tempered glass and two Silver Anodized Aluminum clamps. Holds media 16 1/2" x 23 3/8".	Tempered Glass with two Silver Anodized Aluminum clamps 11 13/16" L	\$665.00

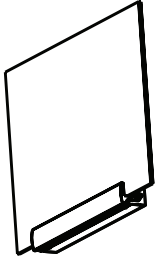

FCL-10  
FCL-20

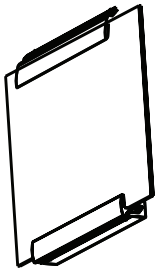

FCL-30  
FCL-40  
FCL-50  
FCL-60

## INFOMERA

MODEL	H	W	D	SHIPPING WEIGHT	DESCRIPTION	COLOR/ FINISH	LIST PRICE
4001	4"	1 1/8"	3 3/4"	1 lb.	Wall mounted mini holder for a media or graphic display. Affixes to wall with screws (not included). Holds media 3" W x 3 15/16" H.	Satin Stainless with clear acrylic	\$71.00
4001-M	4"	1 1/8"	3 3/4"	1 lb.	Magnetic mini holder for a media or graphic display. Holds media 3" W x 3 15/16" H.	Satin Stainless with clear acrylic	\$71.00
4002	3 15/16"	1 1/4"	3"	1 lb.	Wall mounted mini holder for a media or graphic display. Affixes to wall with screws (not included). Holds media 2 5/8" W x 3 7/8" H.	Clear Acrylic	\$41.00

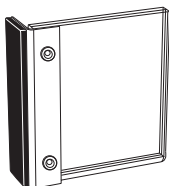

4001-M

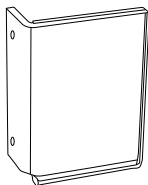

4002

## IFLAG

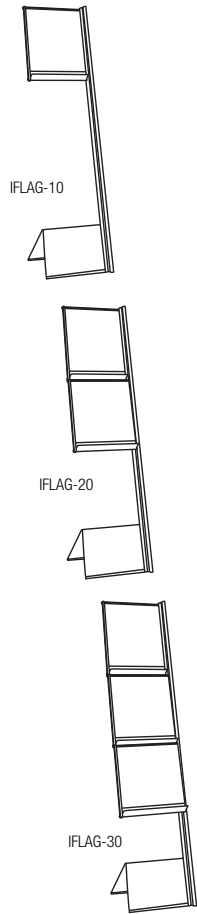





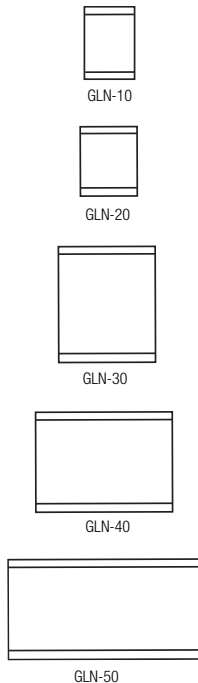

MODEL	H	W	D	SHIPPING WEIGHT	DESCRIPTION	COLOR/ FINISH	LIST PRICE
IFLAG-10	39 3/8"	9 13/16"	17 11/16"	12 lbs.	Transparent methacrylate display for single poster/paper that is 8 1/4" x 11 11/16".	Post in Anodized Silver, base in Textured Black 9011 Textured Forged Grey or White Ral 9010	\$560.00
IFLAG-20	39 3/8"	9 13/16"	17 11/16"	14 lbs.	Transparent methacrylate display for two posters/papers that are 8 1/4" x 11 11/16".	Post in Anodized Silver, base in Textured Black 9011 Textured Forged Grey or White Ral 9010	\$745.00
IFLAG-30	50 13/16"	9 13/16"	17 11/16"	19 lbs.	Transparent methacrylate display for three posters/ papers that are 8 1/4" x 11 11/16".	Post in Anodized Silver, base in Textured Black 9011 Textured Forged Grey or White Ral 9010	\$995.00
IFLAG-40	39 3/8"	9 13/16"	17 11/16"	12 lbs.	Transparent methacrylate display featuring a single shelf for brochures that are 8 1/4" x 11 11/16". Single sheet can also be inserted between methacrylate with brochures or papers on the shelf for take away.	Post in Anodized Silver, base in Textured Black 9011 Textured Forged Grey or White Ral 9010	\$545.00
IFLAG-50	39 3/8"	9 13/16"	17 11/16"	14 lbs.	Transparent methacrylate display featuring two shelves for brochures that are 8 1/4" x 11 11/16". Single sheet can also be inserted between methacrylate with brochures or papers on the shelf or shelves below for take away.	Post in Anodized Silver, base in Textured Black 9011 Textured Forged Grey or White Ral 9010	\$820.00
IFLAG-60	50 13/16"	9 13/16"	17 11/16"	19 lbs.	Transparent methacrylate display featuring three shelves for brochures that are 8 1/4" x 11 11/16". Single sheet can also be inserted between methacrylate with brochures or papers on the shelf or shelves for take away.	Post in Anodized Silver, base in Textured Black 9011 Textured Forged Grey or White Ral 9010	\$1,045.00

## GLASSNOX

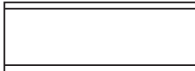

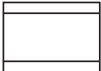
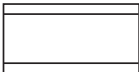
MODEL	H	W	D	SHIPPING WEIGHT	DESCRIPTION	COLOR/ FINISH	LIST PRICE
GLN-10	4 7/16"	3 1/16"	3/8"	1 lb.	Graphic display holder for media 2 29/32" x 4 1/8". Opens easily to exchange information	Brushed Stainless Steel frame with White coated aluminum panel and Crystal Blue acrylic front cover	\$105.00
GLN-20	6 1/8"	4 1/4"	3/8"	1 lb.	Graphic display holder for media 4 1/8" x 5 13/16". vertical. Opens easily to exchange information	Brushed Stainless Steel frame with White coated aluminum panel and Crystal Blue acrylic front cover	\$145.00
GLN-30	6 1/8"	5 15/16"	3/8"	1 lb.	Graphic display holder for media 5 13/16" x 5 13/16". Opens easily to exchange information	Brushed Stainless Steel frame with White coated aluminum panel and Crystal Blue acrylic front cover	\$165.00
GLN-40	6 1/8"	8 3/8"	3/8"	1 lb.	Graphic display holder for media 5 13/16" x 8 1/4" vertical. Opens easily to exchange information	Brushed Stainless Steel frame with White coated aluminum panel and Crystal Blue acrylic front cover	\$190.00
GLN-50	6 1/8"	11 13/16"	3/8"	2 lbs.	Graphic display holder for media 5 13/16" x 11 11/16". vertical. Opens easily to exchange information	Brushed Stainless Steel frame with White coated aluminum panel and Crystal Blue acrylic front cover	\$260.00

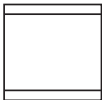
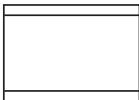
GLASSNOX

MODEL	H	W	D	SHIPPING WEIGHT	DESCRIPTION	COLOR/FINISH	LIST PRICE
 GLN-60	6 1/8"	23 1/2"	3/8"	4 lbs.	Graphic display holder for media 5 13/16" x 23 3/8". Opens easily to exchange information.	Brushed Stainless Steel frame with White coated aluminum panel and Crystal Blue acrylic front cover	\$395.00
 GLN-70	8 9/16"	6 1/8"	3/8"	2 lbs.	Graphic display holder for media 8 1/4" x 5 13/16". Opens easily to exchange information.	Brushed Stainless Steel frame with White coated aluminum panel and Crystal Blue acrylic front cover	\$190.00
 GLN-80	8 9/16"	8 3/8"	3/8"	2 lbs.	Graphic display holder for media 8 1/4" x 8 1/4". Opens easily to exchange information.	Brushed Stainless Steel frame with White coated aluminum panel and Crystal Blue acrylic front cover	\$220.00
 GLN-90	8 9/16"	11 13/16"	3/8"	3 lbs.	Graphic display holder for media 8 1/4" x 11 11/16" vertical. Opens easily to exchange information.	Brushed Stainless Steel frame with White coated aluminum panel and Crystal Blue acrylic front cover	\$290.00
 GLN-100	8 9/16"	16 5/8"	3/8"	3 lbs.	Graphic display holder for media 8 1/4" x 16 1/2". Opens easily to exchange information.	Brushed Stainless Steel frame with White coated aluminum panel and Crystal Blue acrylic front cover	\$350.00
 GLN-110	11 15/16"	8 3/8"	3/8"	3 lbs.	Graphic display holder for media 11 11/16" x 8 1/4" horizontal. Opens easily to exchange information.	Brushed Stainless Steel frame with White coated aluminum panel and Crystal Blue acrylic front cover	\$235.00
 GLN-120	11 15/16"	11 13/16"	3/8"	3 lbs.	Graphic display holder for media 11 11/16" x 11 11/16". Opens easily to exchange information.	Brushed Stainless Steel frame with White coated aluminum panel and Crystal Blue acrylic front cover	\$330.00
 GLN-130	11 15/16"	16 5/8"	3/8"	4 lbs.	Graphic display holder for media 11 11/16" x 16 1/2" vertical. Opens easily to exchange information.	Brushed Stainless Steel frame with White coated aluminum panel and Crystal Blue acrylic front cover	\$395.00
 GLN-140	16 13/16"	11 13/16"	3/8"	4 lbs.	Graphic display holder for media 16 1/2" x 11 11/16" horizontal. Opens easily to exchange information.	Brushed Stainless Steel frame with White coated aluminum panel and Crystal Blue acrylic front cover	\$395.00
 GLN-150	23 11/16"	16 5/8"	3/8"	5 lbs.	Graphic display holder for media 23 3/8" x 16 1/2" vertical. Opens easily to exchange information.	Brushed Stainless Steel frame with White coated aluminum panel and tempered glass front cover	\$575.00



## GLASSNOX



GLN-160



GLN-170

MODEL	H	W	D	SHIPPING WEIGHT	DESCRIPTION	COLOR/ FINISH	LIST PRICE
GLN-160	33 3/8"	23 1/2"	3/8"	6 lbs.†	Graphic display holder for media 33 3/32" x 23 3/8" vertical. Opens easily to exchange information.	Brushed Stainless Steel frame with White coated aluminum panel and tempered glass front panel.	\$885.00
GLN-170	6 1/8"	31 5/8"	3/8"	7 lbs.	Graphic display holder for media 5 13/16 x 31 1/2". Opens easily to exchange information.	Brushed Stainless Steel frame with White coated aluminum panel and plexiglass front cover.	\$475.00

## INFOGLASS



SET-IG10



SET-IG20



SET-IG30

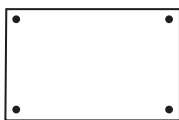

SET-IG40

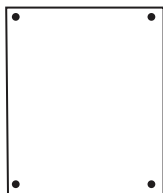



SET-IG50



MODEL	H	W	D	SHIPPING WEIGHT	DESCRIPTION	COLOR/ FINISH	LIST PRICE
SET-IG10	3 1/8"	5 7/8"	3/16"	1 lb.	Graphic display holder constructed of two pieces of tempered glass. Two tamper proof stainless steel fasteners. Holds media 2 29/32" x 4 1/8".	Tempered Glass with two Stainless Steel fasteners.	\$120.00
SET-IG20	5 5/16"	5 7/8"	3/16"	2 lbs.	Graphic display holder constructed of two pieces of tempered glass. Two tamper proof stainless steel fasteners. Holds media 4 1/8" x 5 13/16".	Tempered Glass with two Stainless Steel fasteners.	\$130.00
SET-IG30	5 7/8"	5 7/8"	3/16"	2 lbs.	Graphic display holder constructed of two pieces of tempered glass. Four tamper proof stainless steel fasteners. Holds media 5 13/16" x 5 13/16".	Tempered Glass with four Stainless Steel fasteners.	\$185.00
SET-IG40	8 7/16"	13 1/4"	3/16"	5 lbs.	Graphic display holder constructed of two pieces of tempered glass. Four tamper proof stainless steel fasteners. Holds media 8 1/4" x 11 11/16".	Tempered Glass with four Stainless Steel fasteners.	\$260.00
SET-IG50	18 1/8"	11 13/16"	3/16"	7 lbs..	Graphic display holder constructed of two pieces of tempered glass. Four tamper proof stainless steel fasteners. Holds media 11 11/16" x 16 1/2".	Tempered Glass with four Stainless Steel fasteners.	\$310.00

† Ships via common carrier

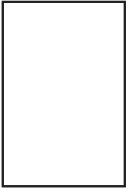
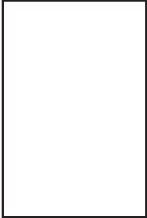
## LUMO



MODEL	H	W	D	SHIPPING WEIGHT	DESCRIPTION	COLOR/ FINISH	LIST PRICE
 LUMO-RA4	13 13/16"	10 5/16"	13/16"	4 lbs.	Wall mounted illuminated poster display. Includes LED lights and power supply. Transparent, flexible polycarbonate cover sheet with magnetic closing and black edges. Holds 8 1/4" x 11 11/16" poster.	Silver Anodized Aluminum frame	\$495.00
 LUMO-RA3	18 5/8"	13 13/16"	13/16"	6 lbs.	Wall mounted illuminated poster display. Includes LED lights and power supply. Transparent, flexible polycarbonate cover sheet with magnetic closing and black edges. Holds 11 11/16" x 16 1/2" poster.	Silver Anodized Aluminum frame	\$595.00
 LUMO-R705	29 5/8"	21 3/4"	13/16"	12 lbs.	Wall mounted illuminated poster display. Includes LED lights and power supply. Transparent, flexible polycarbonate cover sheet with magnetic closing and black edges. Holds 19 11/16" x 27 17/32" poster.	Silver Anodized Aluminum frame	\$995.00
 LUMO-RA1	35 3/16"	25 7/16"	13/16"	16 lbs.	Wall mounted illuminated poster display. Includes LED lights and power supply. Transparent, flexible polycarbonate cover sheet with magnetic closing and black edges. Holds 23 3/8" x 33 3/32" poster.	Silver Anodized Aluminum frame	\$1,095.00
 LUMO-R107	41 1/2"	29 5/8"	13/16"	20 lbs.†	Wall mounted illuminated poster display. Includes LED lights and power supply. Transparent, flexible polycarbonate cover sheet with magnetic closing and black edges. Holds 27 17/32" x 39 3/8" poster.	Silver Anodized Aluminum frame	\$1,495.00

## LUMO IPOINT

MODEL	H	W	D	SHIPPING WEIGHT	DESCRIPTION	COLOR/ FINISH	LIST PRICE
 IPLU-13	53 9/16"	11 5/8"	1 9/16"	49 lbs.†	Floor standing illuminated poster display. Includes LED lights and power supply. Transparent, flexible polycarbonate cover sheet with magnetic closing and black edges. Holds 8 1/4" x 11 11/16" poster.	Silver Anodized Aluminum base and frame	\$1,990.00
 IPLU-19	74 13/16"	23 5/8"	1 9/16"	64 lbs.†	Floor standing illuminated poster display. Includes LED lights and power supply. Transparent, flexible polycarbonate cover sheet with magnetic closing and black edges. Holds 19 11/16" x 27 17/32" poster.	Silver Anodized Aluminum base and frame	\$2,935.00

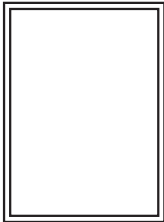
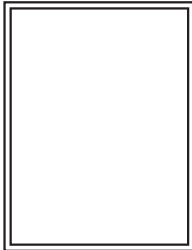
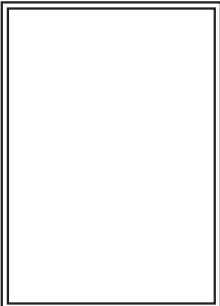
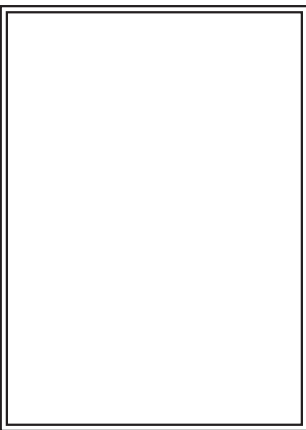

† Ships via common carrier

## MAGNEDOOR

MODEL	H	W	D	SHIPPING WEIGHT	DESCRIPTION	COLOR/ FINISH	LIST PRICE
 MAD-A4	13 3/8"	9 15/16"	13/16"	3 lbs.	Wall mounted poster display. Can be mounted vertically or horizontally. Front cover made of flexible polycarbonate. Silver Grey printed border. Magnetic strip holds front cover in place. For posters 8 1/4" x 11 11/16".	Silver Anodized Aluminum frame with polycarbonate front cover	\$310.00
 MAD-A3	18 1/4"	13 3/8"	13/16"	3 lbs.	Wall mounted poster display. Can be mounted vertically or horizontally. Front cover made of flexible polycarbonate. Silver Grey printed border. Magnetic strip holds front cover in place. For posters 11 11/16" x 16 1/2".	Silver Anodized Aluminum frame with polycarbonate front cover	\$360.00
 MAD-7500	29 1/4"	21 3/8"	13/16"	6 lbs.	Wall mounted poster display. Can be mounted vertically or horizontally. Front cover made of flexible polycarbonate. Silver Grey printed border. Magnetic strip holds front cover in place. For posters 19 11/16" x 27 17/32".	Silver Anodized Aluminum frame with polycarbonate front cover	\$495.00
 MAD-A1	33 1/4"	25 1/16"	13/16"	8 lbs.	Wall mounted poster display. Can be mounted vertically or horizontally. Front cover made of flexible polycarbonate. Silver Grey printed border. Magnetic strip holds front cover in place. For posters 23 3/8" x 33 3/32".	Silver Anodized Aluminum frame with polycarbonate front cover	\$560.00
 MAD-1700	41 1/16"	29 1/4"	13/16"	10 lbs.	Wall mounted poster display. Can be mounted vertically or horizontally. Front cover made of flexible polycarbonate. Silver Grey printed border. Magnetic strip holds front cover in place. For posters 39 3/8" x 27 17/32".	Silver Anodized Aluminum frame with polycarbonate front cover	\$665.00
 MAD-1410	56 13/16"	41 1/16"	13/16"	21 lbs.†	Wall mounted poster display. Can be mounted vertically or horizontally. Front cover made of flexible polycarbonate. Silver Grey printed border. Magnetic strip holds front cover in place. For posters 55 3/32" x 39 3/8".	Silver Anodized Aluminum frame with polycarbonate front cover	\$995.00

† Ships via common carrier

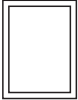
## MAGNEODOOR SLIM

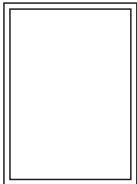
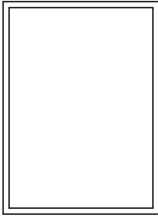
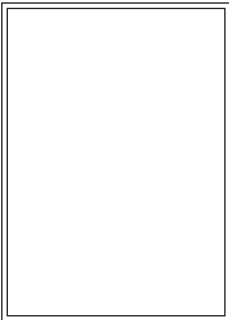
MODEL	H	W	D	SHIPPING WEIGHT	DESCRIPTION	COLOR/ FINISH	LIST PRICE	
MAS-A5	9 3/8"	6 15/16"	1/2"	2 lbs.	Lightweight wall mounted poster display. Can be mounted vertically or horizontally. Front cover removes easily to change poster and is held in place with strong magnetic strip. For posters 5 13/16" x 8 1/4"	Silver Anodized Aluminum frame with non-reflective plastic front cover	\$150.00	
 MAS-A5	MAS-A4	12 13/16"	9 3/8"	1/2"	3 lbs.	Lightweight wall mounted poster display. Can be mounted vertically or horizontally. Front cover removes easily to change poster and is held in place with strong magnetic strip. For posters 11 11/16" x 8 1/4".	Silver Anodized Aluminum frame with non-reflective plastic front cover	\$185.00
 MAS-A4	MAS-A3	17 5/8"	12 13/16"	1/2"	3 lbs.	Lightweight wall mounted poster display. Can be mounted vertically or horizontally. Front cover removes easily to change poster and is held in place with strong magnetic strip. For posters 11 11/16" x 16 1/2".	Silver Anodized Aluminum frame with non-reflective plastic front cover	\$205.00
 MAS-A3	MAS-A2	24 1/2"	17 5/8"	1/2"	6 lbs.	Lightweight wall mounted poster display. Can be mounted vertically or horizontally. Front cover removes easily to change poster and is held in place with strong magnetic strip. For posters 16 1/2" x 23 3/8".	Silver Anodized Aluminum frame with non-reflective plastic front cover	\$310.00
 MAS-A2	MAS-7500	28 11/16"	20 13/16"	1/2"	8 lbs.	Lightweight wall mounted poster display. Can be mounted vertically or horizontally. Front cover removes easily to change poster and is held in place with strong magnetic strip. For posters 19 11/16" x 27 17/32".	Silver Anodized Aluminum frame with non-reflective plastic front cover	\$340.00
 MAS-7500	MAS-A1	47 15/16"	34 3/16"	1/2"	9 lbs.	Lightweight wall mounted poster display. Can be mounted vertically or horizontally. Front cover removes easily to change poster and is held in place with strong magnetic strip. For posters 23 3/8" x 33 3/32".	Silver Anodized Aluminum frame with non-reflective plastic front cover	\$385.00
 MAS-A1								

## MAGINFO SOISTES

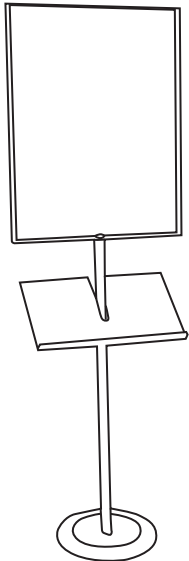

STIF-A3  
W/SOTR 2A4TR

MODEL	H	W	D	SHIPPING WEIGHT	DESCRIPTION	COLOR/ FINISH	LIST PRICE
STIF-A3	56 11/16"	14 1/4"	13"	23 lbs.†	Free standing double-sided poster display features transparent acrylic with magnetic closing system. Holds posters that are 11 11/16" w x 16 1/2" h.	Silver Anodized Aluminum, Silver insert with Chrome ABS base	\$760.00
STIF-700	67 11/16"	22 1/16"	13"	29 lbs.†	Free standing double-sided poster display features transparent acrylic with magnetic closing system. Holds posters that are 19 11/16" w x 27 17/32" h.	Silver Anodized Aluminum, Silver insert with Chrome ABS base	\$1,075.00
STIF-1000	79 1/2"	29 15/16"	13"	36 lbs.†	Free standing double-sided poster display features transparent acrylic with magnetic closing system. Holds posters that are 27 17/32" w x 39 3/8" h.	Silver Anodized Aluminum, Silver insert with Chrome ABS base	\$1,360.00
SOTR-2A4TR	2 5/8"	18 3/4"	12 1/4"	4 lbs.	Accessory brochure holder trays attach to Maginfo post. Includes two holders for 8 1/2" x 11" brochures. Trays are height adjustable on post and can be set horizontally or at 30, 60 or 90 degree angle. Shelf has 1 3/8" lip.	Transparent acrylic	\$185.00

## MAGINFO SLIM SOISTES

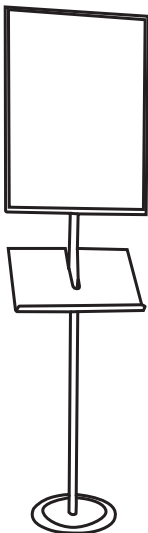

MODEL	H	W	D	SHIPPING WEIGHT	DESCRIPTION	COLOR/ FINISH	LIST PRICE
SOMS-700	76 3/16"	20 13/16"	13"	26 lbs.†	Free standing single-sided poster display. Flexible front cover of non-reflective polycarbonate with magnetic close. Holds poster that is 19 11/16" w x 27 17/32" h	Silver Anodized Aluminum with Silver base	\$795.00
SOMS-A1	76 3/16"	34 3/16"	13"	28 lbs.†	Free standing single-sided poster display. Flexible front cover of non-reflective polycarbonate with magnetic close. Holds poster that is 23 3/8" w x 33 3/32" h.	Silver Anodized Aluminum with Silver base	\$895.000
SOMS-1000	76 3/16"	28 11/16"	13"	29 lbs.†	Free standing single-sided poster display. Flexible front cover of non-reflective polycarbonate with magnetic close. Holds poster that is 27 17/32" w x 39 3/8" h.	Silver Anodized Aluminum with Silver base	\$940.00
SOTR-2A4TR	2 5/8"	18 3/4"	12 1/4"	4 lbs.	Accessory brochure holder trays attach to Maginfo post. Includes two holders for 8 1/2" x 11" brochures. Trays are height adjustable on post and can be set horizontally or at 30, 60 or 90 degree angle. Shelf has 1 3/8" lip.	Transparent acrylic	\$185.00

† Ships via common carrier

## INFOGLASS

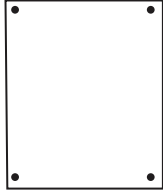

SET-IG50

MODEL	H	W	D	SHIPPING WEIGHT	DESCRIPTION	COLOR/FINISH	LIST PRICE
SET-IG50	18 1/8"	11 13/16"	3/16"	7 lbs..	Graphic display holder constructed of two pieces of tempered glass. Four tamper proof stainless steel fasteners. Holds media 11 11/16" x 16 1/2".	Tempered Glass with four Stainless Steel fasteners.	\$310.00

## SNAPREX

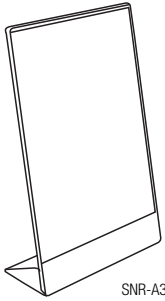

SNR-A3

MODEL	H	W	D	SHIPPING WEIGHT	DESCRIPTION	COLOR/FINISH	LIST PRICE
SNR-A3	18 1/2"	11 11/16"	4"	3 lbs.	Tabletop display including base with acrylic graphic holder. Use vertically or horizontally. Holds graphic that is 16 1/2" x 11 11/16".	Brushed Stainless Steel base with acrylic	\$195.00

## GLASSNOX

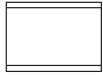

GLN-130

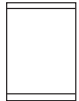

GLN-140

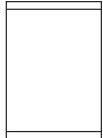

GLN-150

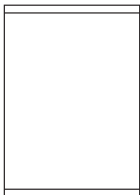

GLN-160

MODEL	H	W	D	SHIPPING WEIGHT	DESCRIPTION	COLOR/FINISH	LIST PRICE
GLN-130	11 15/16"	16 5/8"	3/8"	4 lbs.	Graphic display holder for media 11 11/16" x 16 1/2" vertical. Opens easily to exchange information.	Brushed Stainless Steel frame with White coated aluminum panel and Crystal Blue acrylic front cover	\$395.00
GLN-140	16 13/16"	11 13/16"	3/8"	4 lbs.	Graphic display holder for media 16 1/2" x 11 11/16" horizontal. Opens easily to exchange information.	Brushed Stainless Steel frame with White coated aluminum panel and Crystal Blue acrylic front cover	\$395.00
GLN-150	23 11/16"	16 5/8"	3/8"	5 lbs.	Graphic display holder for media 23 3/8" x 16 1/2" vertical. Opens easily to exchange information.	Brushed Stainless Steel frame with White coated aluminum panel and tempered glass front cover.	\$575.00
GLN-160	33 3/8"	23 1/2"	3/8"	6 lbs.	Graphic display holder for media 33 3/32" x 23 3/8" vertical. Opens easily to exchange information.	Brushed Stainless Steel frame with White coated aluminum panel and tempered glass front cover.	\$885.00

## ARNAGE

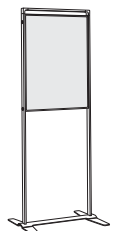

ARNAGE PA P1

MODEL	H	W	D	SHIPPING WEIGHT	DESCRIPTION	COLOR/FINISH	LIST PRICE
ARNAGE PA P1	72 1/4"	28 3/16"	21 5/8"	40 lbs.†	Single sided poster holder with white magnetic steel panel with anti-graffiti epoxy resin finish and clear poly-carbonate screen with magnetic frame. Maximum poster size 31 5/16" x 23 7/16".	White, Black or Silver	\$1,140.00
ARNAGE PA P2	72 1/4"	28 3/16"	21 5/8"	45 lbs.†	Double sided poster holder with white magnetic steel panel with anti-graffiti epoxy resin finish and clear poly-carbonate screen with magnetic frame. Maximum poster size 31 5/16" x 23 7/16".	White, Black or Silver	\$1,755.00

## PADFIX

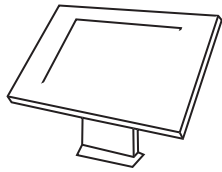

PFX-10AL

MODEL	H	W	D	SHIPPING WEIGHT	DESCRIPTION	COLOR/ FINISH	LIST PRICE
PFX-10AL	8 ¼"	12 3/16"	11"	3 lbs.	iPad* support for securing iPad 2 or 3 to wall or table. Can be turned vertically or horizontally easily. Covered home button protects from unauthorized use. Safety lock included. Notch for charging cable accessibility.	Silver Anodized Aluminum	\$520.00

Padfix works with the following, iPad models: iPad 2, iPad 3rd Gen, iPad 4th Gen, iPad Air, iPad Air 2, iPad Pro 9.7 inch.

\*iPad is a registered trademark of Apple.

## PADLINE

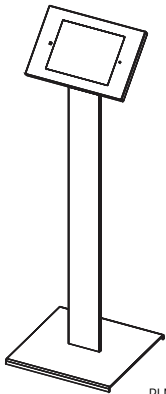

PLN-11AL

MODEL	H	W	D	SHIPPING WEIGHT	DESCRIPTION	COLOR/ FINISH	LIST PRICE
PLN-11AL	43 5/16"	13"	13"	17 lbs.	Holds and protects iPad* models 2 & 3. Can be turned vertically or horizontally. Safety lock and covered iPad buttons prevent unauthorized use and theft. iPad support made of stainless steel with special surface to minimize fingerprints. Menu button can be easily activated with a pointed pen.	Silver Anodized Aluminum with Silver base with die cast ABS cover.	\$835.00
PLN-11BK				19 lbs.		Black powder coated aluminum with Black base with die cast ABS cover. iPad support is Stainless Steel.	\$940.00
PLN-3000				1 lb.	Extension cable with USB and adapter for iPad 2 & 3. Cable is 9' 9" long.	White	\$80.00

Padline works with the following, iPad models: iPad 2, iPad 3rd Gen, iPad 4th Gen, iPad Air, iPad Air 2, iPad Pro 9.7 inch.

\*iPad is a registered trademark of Apple.

## CARTBOX

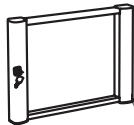

CARTBOX-2A

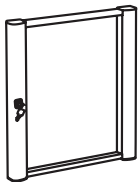

CARTBOX-4A

MODEL	H	W	D	SHIPPING WEIGHT	DESCRIPTION	COLOR/ FINISH	LIST PRICE
CARTBOX-2A	14"	21 7/8"	2 ¼"	9 lbs.	Display cabinet with cylinder lock and plastic front cover. Interior whiteboard for use with non-permanent markers or magnets.	Silver Anodized Aluminum frame, White coated steel panel	\$625.00
CARTBOX-4A	26 1/16"	21 7/8"	2 ¼"	18 lbs.	Display cabinet with cylinder lock and plastic front cover. Interior whiteboard for use with non-permanent markers or magnets.	Silver Anodized Aluminum frame, White coated steel panel	\$835.00

## CARTBOX

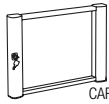

CARTBOX-6A



CARTBOX-9A



CARTBOX-45

MODEL	H	W	D	SHIPPING WEIGHT	DESCRIPTION	COLOR/ FINISH	LIST PRICE
CARTBOX-6A	26 1/16"	30 1/2"	2 1/4"	18 lbs.†	Display cabinet with cylinder lock and plastic front cover. Interior whiteboard for use with non-permanent markers or magnets.	Silver Anodized Aluminum frame, White coated steel panel.	\$1,045.00
CARTBOX-9A	38 1/8"	30 1/2"	2 1/4"	25 lbs.†	Display cabinet with cylinder lock and plastic front cover. Interior whiteboard for use with non-permanent markers or magnets.	Silver Anodized Aluminum frame, White coated steel panel.	\$1,310.00
CARTBOX-45	21 5/8"	19 1/2"	2 1/4"	14 lbs.	Key cabinet with numbering and hooks for up to 45 keys. Cylinder lock and plastic front door.	Silver Anodized Aluminum frame, White coated steel panel.	\$940.00

## MAGO MAGNEDOOR

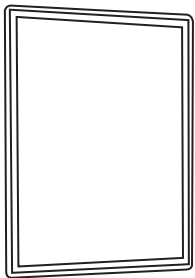

MAGO-4A

MODEL	H	W	D	SHIPPING WEIGHT	DESCRIPTION	COLOR/ FINISH	LIST PRICE
MAGO-2A	15 7/16"	21 5/16"	1"	5 lbs.	Wall cabinet with protective flexible polycarbonate front cover with magnetic closing. Interior whiteboard for use with non-permanent markers or magnets. Magnets included.	Silver Anodized Aluminum frame, White coated steel panel.	\$520.00
MAGO-4A	29 3/16"	21 5/16"	1"	7 lbs.	Wall cabinet with protective flexible polycarbonate front cover with magnetic closing. Interior whiteboard for use with non-permanent markers or magnets. Magnets included.	Silver Anodized Aluminum frame, White coated steel panel.	\$575.00
MAGO-6A	29 3/16"	29 3/16"	1"	16 lbs.	Wall cabinet with protective flexible polycarbonate front cover with magnetic closing. Interior whiteboard for use with non-permanent markers or magnets. Magnets included.	Silver Anodized Aluminum frame, White coated steel panel.	\$775.00

Suitable for sheltered outdoor areas.

## ARNAGE WHITEBOARDS

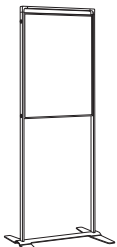

ARNAGE P



ARNAGE M



ARNAGE M1

MODEL	H	W	D	SHIPPING WEIGHT	DESCRIPTION	COLOR/ FINISH	LIST PRICE
ARNAGE P	72 1/4"	28 3/16"	21 5/8"	40 lbs.†	Standing whiteboard with antigraffiti epoxy resin finish. Use with dry erase markers or as display using magnets. Whiteboard area is 25 3/8" W x 35 7/16" H.	White, Black, Silver or Green	\$1,085.00
ARNAGE M	35 7/16"	47 1/4"	1 9/16"	29 lbs.†	Wall mounted whiteboard with anti-graffiti epoxy resin finish. Use with dry erase markers or as display using magnets.	White, Black, Silver or Green	\$695.00
ARNAGE M1	39"	25 3/8"	1 9/16"	30 lbs.†	Vertical wall mounted whiteboard with anti-graffiti epoxy resin finish. Use with dry erase markers or as display using magnets.	White, Black, Silver or Green	\$650.00

† Ships via common carrier



## KP+

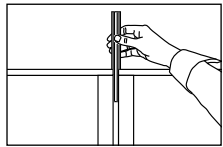
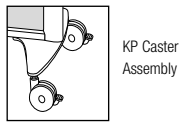
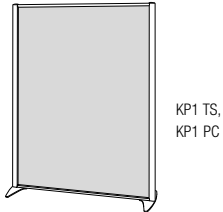
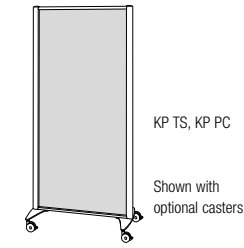

MODEL	H	W	D	SHIPPING WEIGHT	DESCRIPTION	COLOR/FINISH	LIST PRICE
KP TS	64 1/2"	31 15/16"	1 1/8, 18"	46 lbs. †	Free standing moveable screen with steel frame and fabric clad panel. Choose fabric color from selection shown below.	Frame: Argent Silver or Anthracite	\$1,045.00
KP1 TS	64 1/2"	47 1/4"	1 1/8, 18"	63 lbs. †			\$1,095.00
KP PC	64 1/2"	31 15/16"	1 1/8, 18"	27 lbs. †	Free standing moveable screen with steel frame and translucent polycarbonate panel	Frame: Argent Silver or Anthracite with polycarbonate	\$1,150.00
KP1 PC	64 1/2"	47 1/4"	1 1/8, 18"	47 lbs. †			\$1,295.00
KP Caster Assembly-1					Single Caster* assembly for KP+ screens add 3 1/4" to height of unit.	Anthracite or Argent Silver	\$165.00
KP Caster Assembly					Set of two caster assemblies for KP+ screens—add 3/4" to height of unit	Anthracite or Argent Silver	\$325.00

**KP screens can be joined together with a flexible connector (which is provided). When two screens are connected, one can be positioned anywhere along a 180° arc. Up to four screens can be joined together at the same end.**

**\*Single caster assembly is used when joining two units on caster together. Contact customer service for assistance at 1-800-342-5725.**



Other colors available from Interface Fabrics Anchorage collection. Minimum quantities apply. Contact customer service for information.

## MALVA

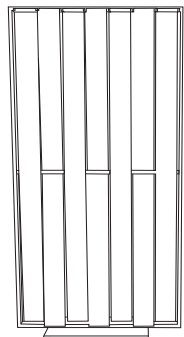

MODEL	H	W	D	SHIPPING WEIGHT	DESCRIPTION	COLOR/FINISH	LIST PRICE
MALVA-H7	75 5/8"	37 1/8"	14 5/8"	49 lbs. †	Sight divider screen with painted aluminum frame and steel base, seven mesh fabric panels.	Frame and base in White Ral 9010, Textured Forged Grey or Black Ral 9011. Mesh screen fabric in Antracite Grey or Light Grey.	\$2,295.00

†Ships via common carrier

PICTOR

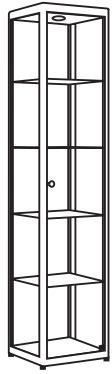

VA040

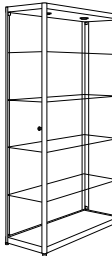

VA100



VA050/K

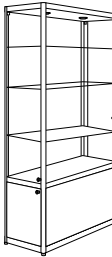

VA100/K

MODEL	H	W	D	SHIPPING WEIGHT	DESCRIPTION	COLOR/FINISH	LIST PRICE
VA040	71 11/16"	15 3/4"	15 3/4"	91 lbs†	Showcase with tempered glass, 1 door with cylinder lock, 4 fully adjustable glass shelves, and a halogen spotlight, 20W.	Black paint or Satin Aluminum	\$3,565.00
VA050	71 11/16"	19 11/16"	19 11/16"	125 lbs†	Showcase with tempered glass, 2 doors (on short sides) with cylinder lock, 4 fully adjustable glass shelves, and 2 halogen spotlights, 20W.	Black paint or Satin Aluminum	\$4,090.00
VA060	71 11/16"	23 5/8"	15 3/4"	121 lbs†	Showcase with tempered glass, 2 doors (on short sides) with cylinder lock, 4 fully adjustable glass shelves, and 2 halogen spotlights, 20W.	Black paint or Satin Aluminum	\$4,195.00
VA080	71 11/16"	31 1/2"	15 3/4"	152 lbs†	Showcase with tempered glass, 2 doors (on short sides) with cylinder lock, 4 fully adjustable glass shelves, and 2 halogen spotlights, 20W.	Black paint or Satin Aluminum	\$5,035.00
VA100	71 11/16"	39 3/8"	15 3/4"	170 lbs†	Showcase with tempered glass, 2 doors (on short sides) with cylinder lock, 4 fully adjustable glass shelves, and 2 halogen spotlights, 20W.	Black paint or Satin Aluminum	\$5,980.00
VA040/K	71 11/16"	15 3/4"	15 3/4"	84 lbs†	Showcase with tempered glass, 1 door with cylinder lock, 3 fully adjustable glass shelves and a halogen spotlight, 20W, fitted with a locking cabinet in the base made of black or silver grey melamine MDF.	Black paint or Satin Aluminum	\$4,095.00
VA050/K	71 11/16"	19 11/16"	19 11/16"	114 lbs†	Showcase with tempered glass, 1 door with cylinder lock, 3 fully adjustable glass shelves and a halogen spotlight, 20W, fitted with a locking cabinet in the base made of black or silver grey melamine MDF.	Black paint or Satin Aluminum	\$4,720.00
VA060/K	71 11/16"	23 5/8"	15 3/4"	108 lbs†	Showcase with tempered glass, 1 door with cylinder lock, 3 fully adjustable glass shelves and a halogen spotlight, 20W, fitted with a locking cabinet in the base made of black or silver grey melamine MDF.	Black paint or Satin Aluminum	\$4,825.00
VA080/K	71 11/16"	31 1/2"	15 3/4"	139 lbs†	Showcase with tempered glass, 2 doors (on short side) with cylinder locks, 3 fully adjustable glass shelves and 2 halogen spotlights, 20W, fitted with a locking cabinet in the base made of black or silver grey melamine MDF.	Black paint or Satin Aluminum	\$5,875.00
VA100/K	71 11/16"	39 3/8"	15 3/4"	150 lbs†	Showcase with tempered glass, 2 doors (on short side) with cylinder locks, 3 fully adjustable glass shelves and 2 halogen spotlights, 20W, fitted with a locking cabinet in the base made of black or silver grey melamine MDF.	Black paint or Satin Aluminum	\$6,495.00

†Ships via common carrier

## TOTEM

MODEL	H	W	D	SHIPPING WEIGHT	DESCRIPTION	COLOR/ FINISH	LIST PRICE
TOTEM 55-3	73 3/4"	24 1/2"	16"	68 lbs.†	Free standing single sided modular shelving unit with three shelves and storage cabinet with magnetic closing. Shelves can be positioned angled or horizontally.	White or Silver frame with shelves in White or Silver	\$2,795.00
TOTEM 55-3B						White or Silver frame with shelves in Beech	\$2,995.00
TOTEM 90-3	73 3/4"	38 1/4"	16"	80 lbs.†	Free standing single sided modular shelving unit with three shelves and storage cabinet with magnetic closing. Shelves can be positioned angled or horizontally.	White or Silver frame with shelves in White or Silver	\$2,995.00
TOTEM 90-3B						White or Silver frame with shelves in Beech	\$3,195.00
TOTEM 55-4	73 3/4"	24 1/2"	15 1/2"	50 lbs.†	Free standing single sided modular shelving unit with four shelves. Shelves can be positioned angled or horizontally.	White or Silver frame with shelves in White or Silver	\$1,995.00
TOTEM 55-4B						White or Silver frame with shelves in Beech	\$2,195.00
TOTEM 90-4	73 3/4"	38 1/4"	15 1/2"	57 lbs.†	Free standing single sided modular shelving unit with four shelves. Shelving can be positioned angled or horizontally.	White or Silver frame with shelves in White or Silver	\$2,195.00
TOTEM 90-4B						White or Silver frame with shelves in Beech	\$2,395.00
TOTEM 55-4A0	73 3/4"	23 1/4"	15 1/2"	31 lbs.†	Add on unit with 4 shelves that can be positioned angled or horizontally.	White or Silver frame with shelves in White or Silver	\$1,595.00
TOTEM 55-4A0B						White or Silver frame with shelves in Beech	\$1,795.00
TOTEM 90-4A0	73 3/4"	37"	15 1/2"	38 lbs.†	Add on unit with 4 shelves that can be positioned angled or horizontally.	White or Silver frame with shelves in White or Silver	\$1,795.00
TOTEM 90-4A0B						White or Silver frame with shelves in Beech	\$1,995.00

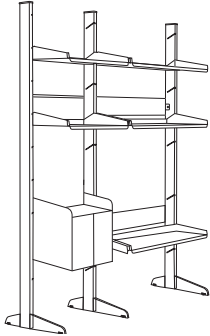

TOTEM 90-3

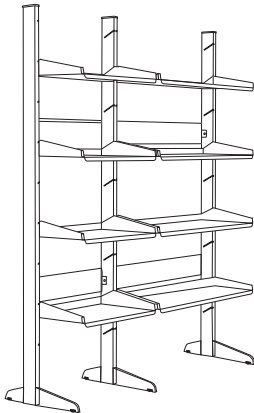

TOTEM 90-4

Depth of unit when shelves are set horizontally is 15 1/2" from front of shelf to back of foot.  
 Depth of unit when shelves are angled is 15 1/8" from front of foot to back of foot.  
 Assembly required.

Note: Totem is a modular shelving system that can be configured in many ways. If you require a specific configuration not listed above, please contact Customer Service for assistance at 800-342-5725.

†Ships via common carrier.

## KOKU

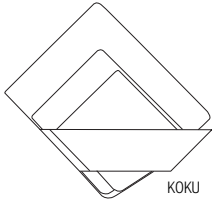

MODEL	H	W	D	SHIPPING WEIGHT	DESCRIPTION	COLOR/FINISH	LIST PRICE
KOKU	6 3/4"	11 1/16"	2 13/16"	4 lbs.	Painted steel wall mounted book shelf with concealed mounting system.	White Ral 9010, Black Ral 9011, Grey Beige Ral 1019, Mustard Ral 1012	\$330.00

## USIO

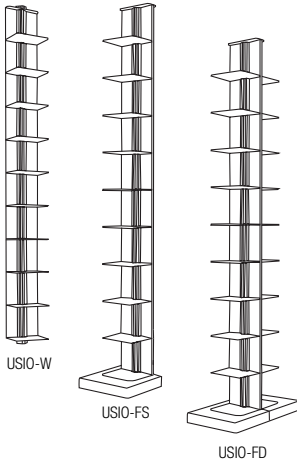

MODEL	H	W	D	SHIPPING WEIGHT	DESCRIPTION	COLOR/FINISH	LIST PRICE
USIO-W	64 1/2"	6 1/4"	6 1/8"	21 lbs.	Wall mounted bookshelf with aluminum center column with 10 painted steel fixed height shelves.	Anodized Silver Matt column, shelves in Forge Grey, White Ral 9010, Black Ral 9011	\$665.00
USIO-FS	64 9/16"	9 3/4"	9 7/8"	35 lbs. †	Floor standing single sided bookshelf with aluminum center column with 10 painted steel fixed height shelves.	Anodized Silver Matt column, shelves in Forge Grey, White Ral 9010, Black Ral 9011	\$1,045.00
USIO-FD	64 9/16"	9 3/4"	19 3/4"	57 lbs. †	Floor standing double sided bookshelf with aluminum center column with 20 painted steel fixed height shelves.	Anodized Silver Matt column, shelves in Forge Grey, White Ral 9010, Black Ral 9011	\$1,570.00

All Usio shelves are 6 1/8" apart.

## TEMPALINE

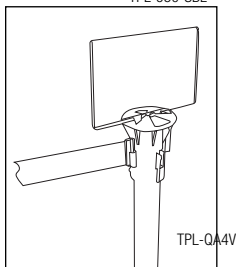
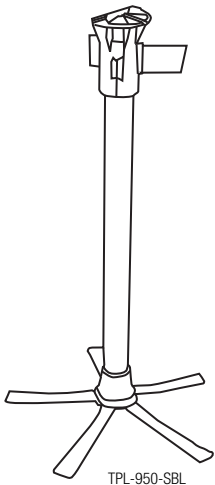

MODEL	H	W	D	SHIPPING WEIGHT	DESCRIPTION	COLOR/FINISH	LIST PRICE
TPL-950-SBL	37 3/8"	20 1/16"	20 1/16"	6 lbs.	Foldable crowd control stanchion for indoor/outdoor use. Blue retractable belt. 6 1/2 ft long. Easy set up.	Silver Matte Anodized Aluminum stanchion, Black ABS plastic base and belt housing	\$595.00
TPL-SET950-SBL	37 3/8"	20 1/16"	20 1/16"	30 lbs.	Set of four foldable crowd control stanchions for indoor/outdoor use. Blue retractable belt 6 1/2 ft long. Includes blue padded carry bag with dual handle and carry strap.	Silver Matte Anodized Aluminum stanchion, Black ABS plastic base and belt housing	\$2,395.00
TPL-QA5H				1 lb.	Double sided poster pocket fits stanchion, portrait orientation. Media size 5 13/16" x 8 1/4".	Clear	\$60.00
TPL-QA4H				1 lb.	Double sided poster pocket fits stanchion, portrait orientation. Media size 8 1/4" x 11 11/16".	Clear	\$80.00
TPL-QA4V				1 lb.	Double sided poster pocket fits stanchion, landscape orientation. Media size 11 11/16" x 8 1/4".	Clear	\$80.00

Tempaline is suitable for outdoor use.

† Ships via common carrier

www.magnusongroup.com (Tel.) 800-342-5725 (Fax) 888-329-4729

## STOPPER ECO

MODEL	H	W	D	SHIPPING WEIGHT	DESCRIPTION	COLOR/ FINISH	LIST PRICE
STOP-SI	38 3/16"	13"	Ø	19 lbs.	Single crowd control post with 97.5" long band.	Silver post, base insert in Black, Glass, Light Grey or Chrome. Band housing in Blue or Black. Band in Black, Blue, Grey or Red.	\$520.00
STOP-AL	38 3/16"	13"	Ø	16 lbs.	Single crowd control post with 97.5" long band.	Aluminum post, base insert in Black, Glass, Light Grey or Chrome. Band housing in Blue or Black. Band in Black, Blue, Grey or Red.	\$520.00
STOP-CH	38 3/16"	13"	Ø	19 lbs.	Single crowd control post with 97.5" long band.	Chrome post, base insert in Black, Glass, Light Grey or Chrome. Band housing in Blue or Black. Band in Black, Blue, Grey or Red.	\$595.00
STOP-BK				19 lbs.	Single crowd control post with 97.5" long band.	Black post, base insert in Black, Glass, Light Grey or Chrome. Band housing in Blue or Black. Band in Black, Blue, Grey or Red.	\$520.00
STOP-01					Acrylic brochure pocket holds 200 single sheet brochures 8 1/4" wide x 11 11/16" high at 30 degree incline	Greenglass	\$195.00
STOP-02					Acrylic poster holder for single sheet 8 1/4" wide x 11 11/16" high – double sided view with magnetic lock.	Greenglass	\$130.00
STWC-90					Wall mount support for use with Stopper.	Nickel plated brass	\$52.00

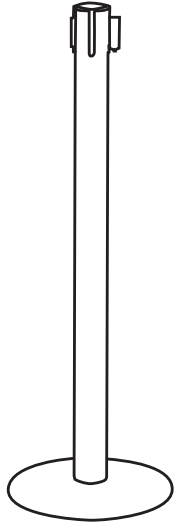

STOP-SI  
STOP-AL  
STOP-CH  
STOP-BK

## POST CLASS

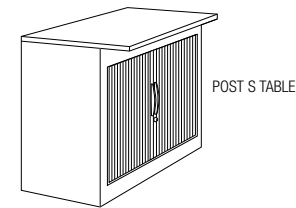
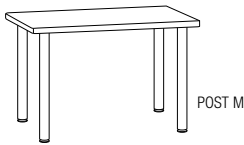
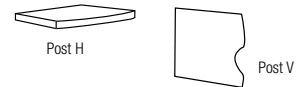
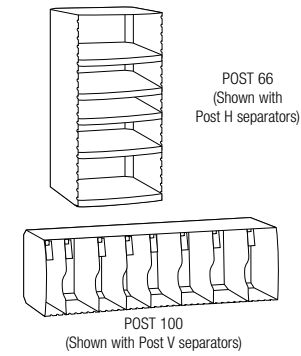

MODEL	H	W	D	SHIPPING WEIGHT	DESCRIPTION	COLOR/ FINISH	LIST PRICE
POST 66	26"	13 1/8"	13 3/8"	33 lbs.†	Mail sorting module. Can be used in vertical or horizontal position.	Grey	\$615.00
POST 100	39 3/8"	13 1/8"	13 3/8"	42 lbs.†	Mail sorting module. Can be used in vertical or horizontal position.	Grey	\$725.00
POST H				2 lbs.	Horizontal shelf for POST 66 or POST 100	Mercury Grey, Anthracite Grey, Lagune Green, Iris Blue	\$35.00
<b>POST 66 accommodates up to 10 shelves. POST 100 accommodates up to 16 shelves.</b>							
POST V				1 lb.	Vertical separator for POST 66 or POST 100	Mercury Grey, Anthracite Grey, Lagune Green, Iris Blue	\$35.00
<b>POST 66 accommodates up to 10 shelves. POST 100 accommodates up to 16 shelves.</b>							
POST M TABLE	33 1/16"	40 3/16"	27 9/16"	66 lbs.†	Table for POST 66 or 100 module	Legs in Beryllium Grey or Argent Silver, Top surface in Flanders Ash, Pear Tree or Grey Melamine	\$1,035.00
POST S TABLE	33 1/16"	39 3/8"	24 7/16"	126 lbs.†	Top with tamber door storage unit beneath with lock		\$2,410.00

## TERTIO MAGNETIC

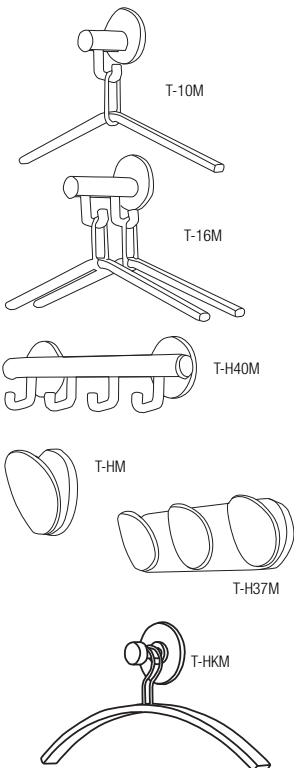

MODEL	H	W	D	SHIPPING WEIGHT	DESCRIPTION	COLOR/ FINISH	LIST PRICE
T-10M	11 13/16"	17 11/16"	3 15/16"	2 lbs.	Magnetic hook with one dark grey plastic hanger.	Aluminum with Dark Grey	\$165.00
T-16M	11 13/16"	17 11/16"	6 5/16"	2 lbs.	Magnetic hook with two dark grey plastic hangers.	Aluminum with Dark Grey	\$235.00
T-H40M	4 1/4"	15 3/4"	1 15/16"	2 lbs.	Magnetic hook strip with four dark grey plastic hooks.	Aluminum with Dark Grey	\$265.00
T-HM	3 3/4"	3 3/4"	1 15/16"	1 lbs.	Magnetic coat hook.	Dark Grey	\$120.00
T-H37M	3 3/4"	14 3/4"	2 3/16"	3 lbs.	Magnetic hook strip with three dark grey plastic hooks.	Dark Grey	\$235.00
T-HKM	8 1/4"	17 15/16"	2 1/2"	2 lbs.	Magnetic hook with hanger.	Black magnet, Brushed Stainless Steel hook with polished steel front, hanger in varnished Beech with Brushed Stainless Steel hook.	\$275.00
<b>All Tertio magnetics hold 17 lbs.</b>							
				† Ships via common carrier			

## MAGNETIC COAT HOOKS

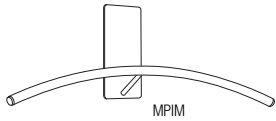

MODEL	H	W	D	SHIPPING WEIGHT	DESCRIPTION	COLOR/ FINISH	LIST PRICE
MPIM	5 1/2"	18"	2 5/8"	2 lbs.	Magnetic coat hanger	White, Black or Silver	\$110.00



MKM	5"	3 3/8"	3"	1 lb.	Magnetic coat hook	Back plate in Black or White, ABS hook in White, Black, Silver, Anthracite, Red or Blue	\$75.00
(See page 113 for matching coat tree and page 108 for matching hook strips.)							

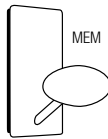

MEM	5"	3 1/8"	3 3/16"	1 lb.	Magnetic coat hook with wood knob	Back plate in Black, White, Sand, Silver, Chocolate or Green, hook in Beech, Wengue, White, Black, Yellow, Green, Blue, Purple or Red	\$92.00
(See page 113 for matching coat tree and page 108 for matching hook strips.)							

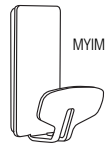

MYIM	5"	3"	1 7/8"	2 lb.	Magnetic coat hook	Back plate and hook in White, Sand, Clay, Silver, Black, Green, Red, Chocolate or Purple	\$105.00
------	----	----	--------	-------	--------------------	--	----------



MYIM-JR.	3"	1 3/8"	1 5/8"	1 lb.	Small magnetic coat hook	Back plate and hook in White, Sand, Clay, Silver, Black, Green, Red, Chocolate or Purple	\$75.00
(See page 113 for matching coat tree, page 123 for matching umbrella stand and page 108 for matching hook strips.)							



MPA-MA	5"	4 3/16"	2 9/16"	2 lbs.	Magnetic coat hook with Black ABS plastic cover.	Black, Silver, White or Sand	\$95.00
(See page 109 for matching hook strips.)							

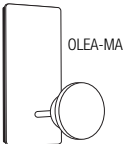

OLEA-MA	5"	2 5/8"	3 3/8"	2 lbs.	Magnetic coat hook with wood knob.	Back plate in Black, Silver or White with knob in Beech or Black	\$91.00
---------	----	--------	--------	--------	------------------------------------	--	---------

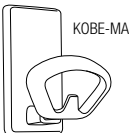

KOBE-MA	5"	4"	2 3/4"	1 lbs.	Magnetic coat hook.	Back plate in White or Black, ABS hook in White, Black, Silver or Red	\$80.00
(See page 113 for matching coat tree and page 108 for matching hook strips..)							

All of the above magnetic hooks hold 13 lbs.

## STICKS MAGNETIC



MODEL	H	W	D	SHIPPING WEIGHT	DESCRIPTION	COLOR/ FINISH	LIST PRICE
STICKS-MA	5"	3 1/2"	3 5/8"	1 lbs.	Magnetic coat hook	Black back plate with hook in Black, White or Silver	\$95.00
(See page 114 for matching coat tree and page 110 for matching hook strips.)							

Magnet weight capacity is 17 lbs.

## NINO MAGNETIC

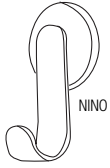

MODEL	H	W	D	SHIPPING WEIGHT	DESCRIPTION	COLOR/FINISH	LIST PRICE
NINO	3"	1 9/16"	1 5/16"	1/4 lb.	Magnetic coat hook with Black round magnet and painted steel hook. <b>Sold in packages of 2</b>	Back plate in Black, hook in Black, White or Metallic Grey	\$130.00 per package of 2 (\$65.00 ea.)

Magnet weight capacity is 2.2 lbs.

## UNDER TABLE PURSE HOOK



MODEL	H	W	D	SHIPPING WEIGHT	DESCRIPTION	COLOR/FINISH	LIST PRICE
YIN-PH	1 3/8"	1 3/8"	1 5/8"	1 lbs.	Under table or counter hook to hold purses or bags.	White, Sand or Black	\$50.00

## TUBULUS H

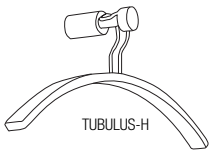

MODEL	H	W	D	SHIPPING WEIGHT	DESCRIPTION	COLOR/FINISH	LIST PRICE
TUB-H	1"	1 5/16"	2 1/16"	1 lb.	Coat hook	Brushed Stainless with front in Polished Stainless Steel.	\$125.00
TUB-H10	6 11/16"	17 15/16"	3 15/16"	2 lb.	Coat hook with hanger.	Brushed Stainless hook with front in Polished Stainless Steel, hanger in varnished Beech with Brushed Stainless hook.	\$295.00

## STICKS FM

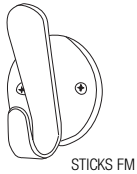

MODEL	H	W	D	SHIPPING WEIGHT	DESCRIPTION	COLOR/FINISH	LIST PRICE
STICKS-FM	4 7/8"	3 1/8"	2 1/2"	1 lb.	Front mount coat hook with back plate and plastic hook in Black, White or Silver	White, Black or Silver	\$110.00

## TREEHOOKED

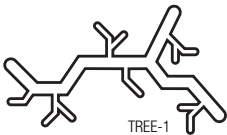

MODEL	H	W	D	SHIPPING WEIGHT	DESCRIPTION	COLOR/FINISH	LIST PRICE
TREE-1	10 5/8"	23 1/4"	1 3/16"	5 lbs.	Wall mounted coat rack. Can be used individually or in groups.	Red, Green, Grey, White or Black Ral finishes	\$225.00

## CIRCUS

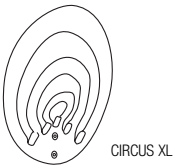

MODEL	H	W	D	SHIPPING WEIGHT	DESCRIPTION	COLOR/FINISH	LIST PRICE
CIRCUS XL	11 13/16"	11 13/16"	1 3/4"	4 lbs.	Coat Hook	Black, Metallic Grey, White, Red, Orange or Green	\$205.00

## MIRAC

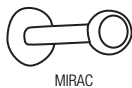

MODEL	H	W	D	SHIPPING WEIGHT	DESCRIPTION	COLOR/FINISH	LIST PRICE
MIRAC-HK1	1"	3/4"	1 3/8"	1/4 lb.	Single coat Hook	Chromed Brass	\$29.00
MIRAC-HK2	1"	3/4"	2 3/8"	1/4 lb.	Single coat Hook	Chromed Brass	\$35.00

(See page 114 for matching coat tree and page 110 for matching hook strips.)



## BAMBU

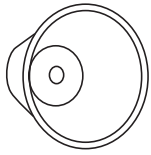

BAMBU-08

MODEL	H	W	D	SHIPPING WEIGHT	DESCRIPTION	COLOR/FINISH	LIST PRICE
BAMBU-06	1 3/8"	Ø	1 9/16"	1/4 lb.	Small ABS plastic hook.	Grey White Ral 9002 or Grey Ral 7022	\$15.00
BAMBU-08	3 3/8"	Ø	1 9/16"	1/2 lb.	Large ABS plastic hook.	Grey White Ral 9002 or Grey Ral 7022	\$16.00

## POINTO



POINTO-10



POINTO-20

MODEL	H	W	D	SHIPPING WEIGHT	DESCRIPTION	COLOR/FINISH	LIST PRICE
POINTO-10	3"	3"	2 3/8"	1 lb.	Round epoxy coated steel coat hook.	Satin Grey Beige Ral 1019, Satin Mustard Ral 1012, Black Ral 9011 or White Ral 9010.	\$110.00
POINTO-20	3"	3"	2 3/8"	1 lb.	Square epoxy coated steel coat hook.	Satin Grey Beige Ral 1019, Satin Mustard Ral 1012, Black Ral 9011 or White Ral 9010.	\$110.00

## K SERIES

Use FM hooks when mounting directly into a wall, door, or surface; or when access to the back of the knob cannot be reached.

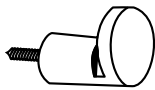
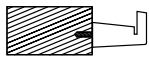

K-50C/FM  
K-50BC/FM  
K-50N/FM



K-55C/FM  
K-55BC/FM  
K-55N/FM

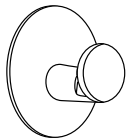

K-50/FMP

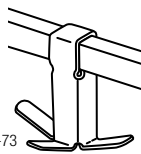

K-73

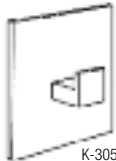

K-305



K-300



K-315

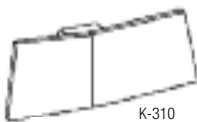

K-310



K-320

MODEL	H	W	D	SHIPPING WEIGHT	DESCRIPTION	COLOR/FINISH	LIST PRICE
<b>K-50C/FM</b>	1 1/4"	1 1/4"	1 9/16"	1/4 lb.	Zinc die cast knob	<b>Polished Chrome</b>	\$37.00
<b>K-50BC/FM</b>	1 1/4"	1 1/4"	1 9/16"	1/4 lb.	Zinc die cast knob	<b>Brushed Chrome</b>	\$39.00
K-50N/FM	1 1/4"	1 1/4"	1 9/16"	1/4 lb.	Zinc die cast knob, Powder coat finish	Black or Sandstone	\$34.00
<b>K-55C/FM</b>	1 3/8"	1 3/8"	2 13/16"	1/2 lb.	Zinc die cast knob	<b>Polished Chrome</b>	\$39.00
<b>K-55BC/FM</b>	1 3/8"	1 3/8"	2 13/16"	1/2 lb.	Zinc die cast knob	<b>Brushed Chrome</b>	\$42.00
K-55N/FM	1 3/8"	1 3/8"	2 13/16"	1/2 lb.	Zinc die cast knob, Powder coat finish	Black, or Sandstone	\$38.00
K-50/FMP	3"	3"	1 3/4"	1 lb.	Die cast steel garment bag hook	Brushed Chrome or Polished Chrome	\$70.00
K-73	3 1/4"	4"	2 1/2"	1/4 lb.	Triple prong hook for 3/4" square tubing	Charcoal Grey, Black, or Sandstone Vinyl coating	\$19.00
K-300C	4 9/16"	3 3/8"	2"	1 lb.	Aluminum hook	Chrome	\$64.00
K-300MS	4 9/16"	3 3/8"	2"	1 lb.	Aluminum hook	Metallic Silver	\$60.00
K-305MS	3 3/16"	3 3/16"	1 1/16"	1 lb.	Aluminum hook	Metallic Silver	\$49.00
K-310C	1 1/2"	3 1/2"	1 1/4"	1 lb.	Zinc hook	Chrome	\$41.00
K-310MS	1 1/2"	3 1/2"	1 1/4"	1 lb.	Zinc hook	Metallic Silver	\$36.00
K-315C	2 3/16"	2 1/2"	1 1/4"	1 lb.	Zinc hook	Chrome	\$47.00
K-320C	4"	3/8"	2 5/16"	1 lb.	Aluminum hook	Chrome	\$35.00
K-320MS	4"	3/8"	2 5/16"	1 lb.	Aluminum hook	Metallic Silver	\$30.00

**Bold** denotes quick ship  
See page 7 for details

## K SERIES

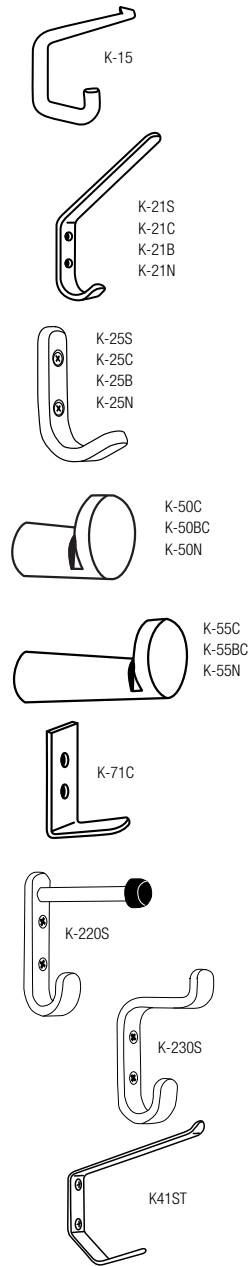

MODEL	H	W	D	SHIPPING WEIGHT	DESCRIPTION	COLOR/ FINISH	LIST PRICE
K-15	3 11/16"	3/4"	3 1/8"	1/4 lb.	Nylon	Dark Grey	\$16.00
<b>K-21S</b>	5 7/8"	7/8"	3 7/8"	1/4 lb.	Aluminum Hook	<b>Silver Anodized</b>	\$37.00
K-21C	5 7/8"	7/8"	3 7/8"	1/4 lb.	Aluminum Hook	Chrome Anodized	\$40.00
K-21B	5 7/8"	7/8"	3 7/8"	1/4 lb.	Aluminum Hook	Bronze Anodized	\$42.00
K-21N	5 7/8"	7/8"	3 7/8"	1/4 lb.	Aluminum Hook Powder coat finish	Black or Sandstone	\$37.00
K-25S	3"	7/8"	2 1/8"	1/4 lb.	Aluminum Hook	Silver Anodized	\$25.00
K-25C	3"	7/8"	2 1/8"	1/4 lb.	Aluminum Hook	Chrome Anodized	\$26.00
K-25B	3"	7/8"	2 1/8"	1/4 lb.	Aluminum Hook	Bronze Anodized	\$29.00
K-25N	3"	7/8"	2 1/8"	1/4 lb.	Aluminum Hook Powder coat finish	Black or Sandstone	\$25.00
<b>K-50C</b>	1 1/4"	1 1/4"	1 9/16"	1/4 lb.	Zinc die cast knob	<b>Polished Chrome</b>	\$34.00
<b>K-50BC</b>	1 1/4"	1 1/4"	1 9/16"	1/4 lb.	Zinc die cast knob	<b>Brushed Chrome</b>	\$38.00
K-50N	1 1/4"	1 1/4"	1 9/16"	1/4 lb.	Zinc die cast knob, Powder coat finish	Black or Sandstone	\$33.00
<b>K-55C</b>	1 3/8"	1 3/8"	2 13/16"	1/2 lb.	Zinc die cast knob	<b>Polished Chrome</b>	\$38.00
<b>K-55BC</b>	1 3/8"	1 3/8"	2 13/16"	1/2 lb.	Zinc die cast knob	<b>Brushed Chrome</b>	\$40.00
K-55N	1 3/8"	1 3/8"	2 13/16"	1/2 lb.	Zinc die cast knob, Powder coat finish	Black or Sandstone	\$37.00
K-71C	2 1/4"	3/4"	1 3/4"	1/4 lb.	Steel hook	Chrome	\$7.00
K-220S	3 13/16"	7/8"	3 3/4"	1/2 lb.	Aluminum hook with door stop	Silver Anodized	\$86.00
K-230S	4 1/4"	7/8"	2 15/16"	1/2 lb.	Aluminum hook	Silver Anodized	\$59.00
K41ST	5 1/8"	3/4"	4"	1/2 lb.	Stainless steel hook	Stainless steel	\$20.00

## K SERIES HOOK PANELS

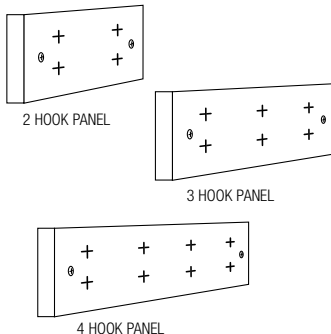

Above hooks are available mounted on laminate panels in configurations of 2, 3 or 4 hook units. Invoice will reflect finished product number; i.e. 2K21S, 3K50C, 4K55BC.

MODEL	H	W	D	SHIPPING WEIGHT	DESCRIPTION	COLOR/ FINISH	LIST PRICE
12" Panel	4"	12"	3/4"	3 lbs. w/hooks	High pressure laminate panel	Oak, Walnut, Featherstone Grey, Black, Victorian Cherry or Mahogany	\$26.00
For 2 hooks							
18" Panel	4"	18"	3/4"	4 lbs. w/hooks	High pressure laminate panel	Oak, Walnut, Featherstone Grey, Black, Victorian Cherry or Mahogany	\$35.00
For 3 hooks							
34" Panel	4"	34"	3/4"	5 lbs. w/hooks	High pressure laminate panel	Oak, Walnut, Featherstone Grey, Black, Victorian Cherry or Mahogany	\$42.00
For 4 hooks							

**Bold** denotes quick ship. See page 7 for details

## PC SERIES PANEL/DOOR

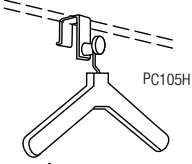
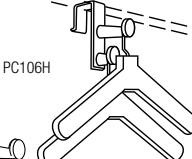
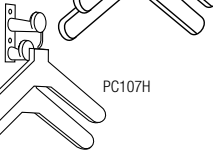
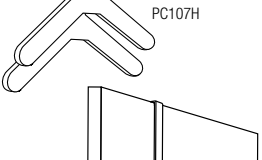
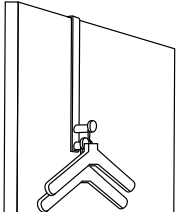
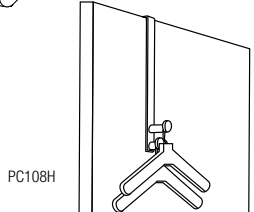
	MODEL	H	W	D	SHIPPING WEIGHT	DESCRIPTION	COLOR/ FINISH	LIST PRICE
	PC-105H	4"	1 3/4"	1 3/4"	2 lbs.	Over panel costumer with 1 hanger	Charcoal Grey, Black	\$47.00
	PC-106H	6"	1 3/4"	3"	2 lbs.	Over panel costumer with 2 hangers	Charcoal Grey, Black	\$58.00
	PC-205H	4"	3 1/2"	1 3/4"	2 lbs.	Over panel costumer with 1 hanger	Charcoal Grey, Black	\$48.00
	PC-206H	6"	3 1/2"	3"	2 lbs.	Over panel costumer with 2 hangers	Charcoal Grey, Black	\$60.00
	PC-107H	4"	1"	3"	2 lbs.	Wall or door mounted costumer with 2 hangers	Charcoal Grey, Black, Sandstone Polished or Satin Chrome	\$57.00 \$76.00
	PC-108H	15 1/2"	1"	3"	2 lbs.	Over door costumer with 2 hangers <b>longer size available</b>	Charcoal Grey, Black	\$68.00

## PC 550 SERIES

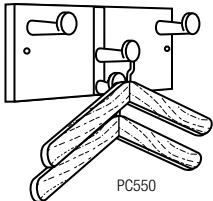
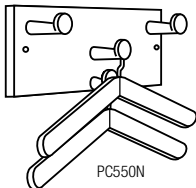
	MODEL	H	W	D	SHIPPING WEIGHT	DESCRIPTION	COLOR/ FINISH	LIST PRICE
	PC-550	6"	18"	3 9/16"	5 lbs.	Executive wall costumer	<b>Oak, Walnut, Mahogany, Black or Victorian Cherry</b> laminate with polished chrome knobs, matching hangers	\$165.00
	PC-550N	6"	18"	3 9/16"	5 lbs.	Wall costumer	Oak, Walnut, Mahogany, Black, Victorian Cherry, or Featherstone Grey laminate panel; hooks in Sandstone or Black, Hangers in Oak, Walnut, Mahogany, Victorian Cherry, Sandstone or Black	\$168.00

## TERTIO H-K

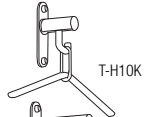
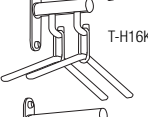
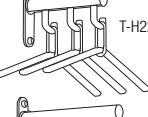
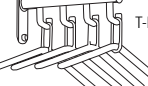
	MODEL	H	W	D	SHIPPING WEIGHT	DESCRIPTION	COLOR/ FINISH	LIST PRICE
	T-H10K	11 13/16"	17 11/16"	3 15/16"	2 lb.	Wall mounted coat rack with one dark grey plastic coat hanger.	Dark Grey with Satin Aluminum.	\$175.00
	T-H16K	11 13/16"	17 11/16"	6 5/16"	3 lb.	Wall mounted coat rack with two dark grey plastic coat hangers.	Dark Grey with Satin Aluminum.	\$205.00
	T-H22K	11 13/16"	17 11/16"	8 11/16"	3 lb.	Wall mounted coat rack with three dark grey plastic coat hangers.	Dark Grey with Satin Aluminum.	\$250.00
	T-H28K	11 13/16"	17 11/16"	11 1/16"	3 lb.	Wall mounted coat rack with four dark grey plastic coat hangers.	Dark Grey with Satin Aluminum.	\$285.00

**Bold** denotes quick ship  
See page 7 for details.

### KYOTO MKW SERIES

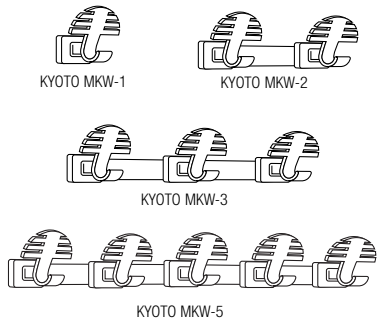

MODEL	H	W	D	SHIPPING WEIGHT	DESCRIPTION	COLOR/ FINISH	LIST PRICE
MKW-1	2 7/8"	3 3/8"	3"	1/4 lb.	Hook strip with single coat hook.	Black back plate, ABS hook in White, Black, Silver, Anthracite, Red or Blue	\$37.00
MKW-2	2 7/8"	8 5/8"	3"	3/4 lb.	Hook strip with two coat hooks	Black back plate, ABS hook in White, Black, Silver, Anthracite, Red or Blue	\$58.00
MKW-3	2 7/8"	16 5/8"	3"	1 lb.	Hook strip with three coat hook	Black back plate, ABS hook in White, Black, Silver, Anthracite, Red or Blue	\$86.00
MKW-5	2 7/8"	23 5/16"	3"	2 lb.	Hook strip with five coat hook	Black back plate, ABS hook in White, Black, Silver, Anthracite, Red or Blue	\$116.00

(See page 113 for matching coat tree and page 103 for magnetic hook.)

### ALOES MEW SERIES

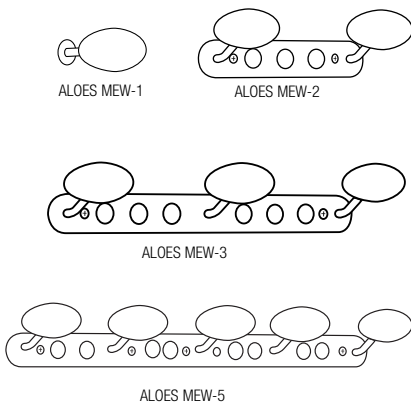

MODEL	H	W	D	SHIPPING WEIGHT	DESCRIPTION	COLOR/ FINISH	LIST PRICE
MEW-1	2 3/4"	3 1/4"	3 3/16"	1 lb.	Hook strip with single coat hook.	Strip in White, Sand, Silver, Black, Green or Chocolate, knob in Beech, Wengue, White, Black, Yellow, Green, Blue, Purple or Red	\$34.00
MEW-2	2 3/4"	9 7/8"	3 3/16"	2 lbs.	Hook strip with two coat hooks.	Strip in White, Sand, Silver, Black, Green or Chocolate, knob in Beech, Wengue, White, Black, Yellow, Green, Blue, Purple or Red	\$98.00
MEW-3	2 3/4"	16 9/16"	3 3/16"	3 lbs.	Hook strip with three coat hooks.	Strip in White, Sand, Silver, Black, Green or Chocolate, knob in Beech, Wengue, White, Black, Yellow, Green, Blue, Purple or Red	\$126.00
MEW-5	2 3/4"	29 15/16"	3 3/16"	5 lbs.	Hook strip with five coat hooks.	Strip in White, Sand, Silver, Black, Green or Chocolate, knob in Beech, Wengue, White, Black, Yellow, Green, Blue, Purple or Red	\$179.00

(See page 113 for matching coat tree and page 103 for magnetic hook.)

### YIN MYIW SERIES

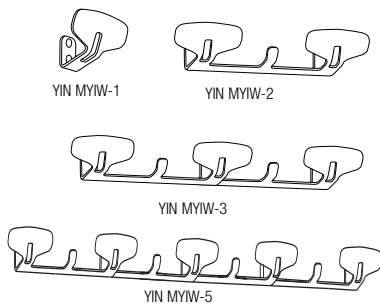

MODEL	H	W	D	SHIPPING WEIGHT	DESCRIPTION	COLOR/ FINISH	LIST PRICE
MYIW-1	2 1/4"	3"	2"	2 lbs.	Hook strip with single coat hook.	White, Sand, Clay, Silver, Black, Green, Red, Chocolate or Purple	\$68.00
MYIW-2	2 1/4"	9 13/16"	2"	3 lbs.	Hook strip with two coat hooks.	White, Sand, Clay, Silver, Black, Green, Red, Chocolate or Purple	\$95.00
MYIW-3	2 1/4"	15 9/16"	2"	4 lbs.	Hook strip with three coat hooks.	White, Sand, Clay, Silver, Black, Green, Red, Chocolate or Purple	\$121.00
MYIW-5	2 1/4"	32"	2"	6 lbs.	Hook strip with five coat hooks.	White, Sand, Clay, Silver, Black, Green, Red, Chocolate or Purple	\$179.00

(See page 113 for matching coat tree, page 123 for umbrella stand, page 103 for magnetic hook.)

### KOBE SERIES

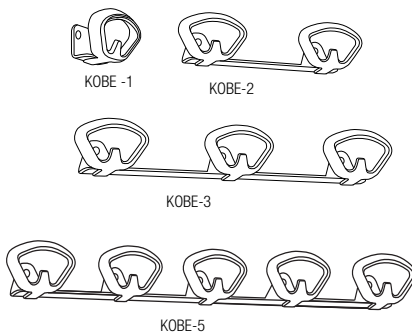

MODEL	H	W	D	SHIPPING WEIGHT	DESCRIPTION	COLOR/ FINISH	LIST PRICE
KOBE-1	3 3/16"	3 13/16"	2 3/4"	1 lb.	Hook strip with single coat hook.	Black strip with ABS hook in White, Black, Silver or Red	\$34.00
KOBE-2	3 3/16"	10 7/16"	2 3/4"	2 lb.	Hook strip with two coat hooks.	Black strip with ABS hook in White, Black, Silver or Red	\$53.00
KOBE-3	3 3/16"	17 1/8"	2 3/4"	3 lb.	Hook strip with three coat hooks.	Black strip with ABS hook in White, Black, Silver or Red	\$79.00
KOBE-5	3 3/16"	30 1/2"	2 3/4"	5 lb.	Hook strip with five coat hooks.	Black strip with ABS hook in White, Black, Silver or Red	\$110.00

(See page 113 for matching coat tree and page 103 for magnetic hook.)

## MPAM SERIES

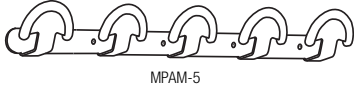
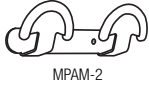

MODEL	H	W	D	SHIPPING WEIGHT	DESCRIPTION	COLOR/FINISH	LIST PRICE
MPAM-2	3 3/16"	10 7/8"	2 9/16"	4 lbs.	Wall mounted strip with 2 hooks. Hooks have Black ABS plastic covers	Black, White, Sand or Silver	\$95.00
MPAM-3	3 3/16"	17 9/16"	2 9/16"	5 lbs.	Wall mounted strip with 3 hooks. Hooks have Black ABS plastic covers	Black, White, Sand or Silver	\$121.00
MPAM-5	3 3/16"	30 7/8"	2 9/16"	7 lbs.	Wall mounted strip with 5 hooks. Hooks have Black ABS plastic covers	Black, White, Sand or Silver	\$168.00

## STAINLESS STEEL SERIES

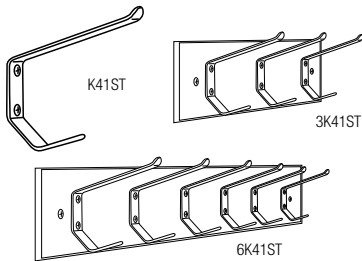

MODEL	H	W	D	SHIPPING WEIGHT	DESCRIPTION	COLOR/FINISH	LIST PRICE
K-41ST	5 1/8"	3/4"	4"	1/2 lb.	Single hook	<b>Stainless Steel</b>	\$20.00
2K-41ST	4"	12"	4 1/4"	3 lbs.	Two hook panel	<b>Stainless Steel</b>	\$63.00
3K-41ST	4"	18"	4 1/4"	4 lbs.	Three hook panel	<b>Stainless Steel</b>	\$86.00
6K-41ST	4"	36"	4 1/4"	6 lbs.	Six hook panel	<b>Stainless Steel</b>	\$127.00

## ONA

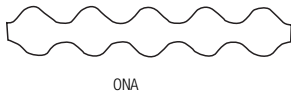

MODEL	H	W	D	SHIPPING WEIGHT	DESCRIPTION	COLOR/FINISH	LIST PRICE
ONA	7 1/2"	38 3/16"	5 7/8"	5 lb.	Laminated wooden hook strip.	Oak, Ral 9002 Grey White, Grey, Green, Walnut or Bordeaux	\$485.00

**Bold** denotes quick ship  
See page 7 for details.

## SEI



MODEL	H	W	D	SHIPPING WEIGHT	DESCRIPTION	COLOR/ FINISH	LIST PRICE
SEI-10	7 1/16"	9 13/16"	2 15/16"	4 lbs.	Hook strip with two epoxy coated steel hat and coat hooks	Black, Metallic Grey or White	\$310.00
SEI-20	7 1/16"	17 11/16"	2 15/16"	6 lbs.	Hook strip with three epoxy coated steel hat and coat hooks.	Black, Metallic Grey or White	\$395.00

## STICKS HJH



MODEL	H	W	D	SHIPPING WEIGHT	DESCRIPTION	COLOR/ FINISH	LIST PRICE
STICKS-HJH-30	4 15/16"	11 13/16"	2 15/16"	1 lb.	Hook rail with two white plastic hat and coat hooks.	Varnished Natural Oak rail	\$220.00
STICKS-HJH-60	4 15/16"	23 5/8"	2 15/16"	2 lbs.	Hook rail with five white plastic hat and coat hooks.	Varnished Natural Oak rail	\$340.00
STICKS-HJH-90	4 15/16"	35 7/16"	2 15/16"	3 lbs.	Hook rail with eight white plastic hat and coat hooks.	Varnished Natural Oak rail	\$455.00

(See page 114 for matching coat tree and page 103 for magnetic hook.)

## CLIMB

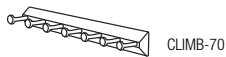
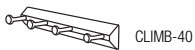
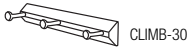

MODEL	H	W	D	SHIPPING WEIGHT	DESCRIPTION	COLOR/ FINISH	LIST PRICE
CLIMB-10	1 15/16"	1 3/4"	2 1/2"	1/4 lb.	Anodized aluminum hook rail with single hook.	Silver Matte Aluminum	\$90.00
CLIMB-20	1 15/16"	7 5/8"	2 1/2"	1/2 lb.	Anodized aluminum hook rail with two hooks.	Silver Matte Aluminum	\$130.00
CLIMB-30	1 15/16"	13 3/4"	2 1/2"	1 1/2 lbs.	Anodized aluminum hook rail with three hooks.	Silver Matte Aluminum	\$180.00
CLIMB-40	1 15/16"	19 7/16"	2 1/2"	1 3/4 lbs.	Anodized aluminum hook rail with four hooks.	Silver Matte Aluminum	\$225.00
CLIMB-70	1 15/16"	37 3/16"	2 1/2"	3 lbs.	Anodized aluminum hook rail with seven hooks.	Silver Matte Aluminum	\$360.00

## MIRAC

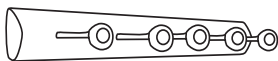





MIRAC-50



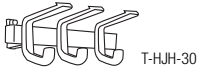

MODEL	H	W	D	SHIPPING WEIGHT	DESCRIPTION	COLOR/ FINISH	LIST PRICE
MIRAC-50	1 5/8"	19 11/16"	3 1/8"	2 lbs.	Aluminum hook rail with five chromed brass hooks.	Aluminum Ra1 9006	\$235.00

(See page 114 for matching coat tree and page 104 for matching hooks.)

### TERTIO HJH

	MODEL	H	W	D	SHIPPING WEIGHT	DESCRIPTION	COLOR/ FINISH	LIST PRICE
	T-HJH-30	3 3/4"	11 13/16"	4 3/4"	2 lbs.	Hook rail with three grey plastic hat & coat hooks.	Anodized Aluminum strip, Dark Grey supports	\$90.00
	T-HJH-60	3 3/4"	23 5/8"	4 3/4"	3 lbs.	Hook rail with six grey plastic hat & coat hooks.	Anodized Aluminum strip, Dark Grey supports	\$175.00
	T-HJH-90	3 3/4"	35 7/16"	4 3/4"	4 lbs.	Hook rail with nine grey plastic hat & coat hooks.	Anodized Aluminum strip, Dark Grey supports	\$230.00
	T-HJH-120	3 3/4"	47 1/4"	4 3/4"	5 lbs.	Hook rail with twelve grey plastic hat & coat hooks.	Anodized Aluminum strip, Dark Grey supports	\$290.00



### TERTIO H

	MODEL	H	W	D	SHIPPING WEIGHT	DESCRIPTION	COLOR/ FINISH	LIST PRICE
	T-H-30	3 1/8"	11 13/16"	3 1/8"	2 lbs.	Round hook rail with three grey plastic hooks.	Anodized Aluminum strip, Dark Grey supports.	\$90.00
	T-H-60	3 1/8"	23 5/8"	3 1/8"	3 lbs.	Round hook rail with six grey plastic hooks.	Anodized Aluminum strip, Dark Grey supports.	\$140.00
	T-H-90	3 1/8"	35 7/16"	3 1/8"	3 lbs.	Round hook rail with nine grey plastic hooks.	Anodized Aluminum strip, Dark Grey supports.	\$195.00
	T-H-120	3 1/8"	47 1/4"	3 1/8"	4 lbs.	Round hook rail with twelve grey plastic hooks.	Anodized Aluminum strip, Dark Grey supports.	\$245.00

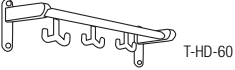
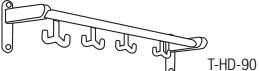
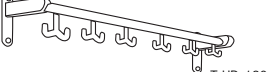
### TERTIO HD

	MODEL	H	W	D	SHIPPING WEIGHT	DESCRIPTION	COLOR/ FINISH	LIST PRICE
	T-HD-60	6 5/16"	23 5/8"	5 7/8"	5 lbs.	Hook rail with three double prong grey plastic hooks.	Anodized Aluminum strip, Dark Grey supports.	\$205.00
	T-HD-90	6 5/16"	35 7/16"	5 7/8"	7 lbs.	Hook rail with four double prong grey plastic hooks.	Anodized Aluminum strip, Dark Grey supports.	\$235.00
	T-HD-120	6 5/16"	47 1/4"	5 7/8"	8 lbs.	Hook rail with six double prong grey plastic hooks.	Anodized Aluminum strip, Dark Grey supports.	\$275.00

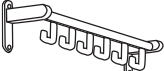
### TERTIO HA

	MODEL	H	W	D	SHIPPING WEIGHT	DESCRIPTION	COLOR/ FINISH	LIST PRICE
	T-HA-60	6 5/16"	23 5/8"	5 7/8"	5 lbs.	Hook rail with six grey plastic hooks.	Anodized Aluminum strip, Dark Grey supports.	\$205.00
	T-HA-90	6 5/16"	35 7/16"	5 7/8"	7 lbs.	Hook rail with nine grey plastic hooks.	Anodized Aluminum strip, Dark Grey supports.	\$235.00
	T-HA-120	6 5/16"	47 1/4"	5 7/8"	8 lbs.	Hook rail with twelve grey plastic hooks.	Anodized Aluminum strip, Dark Grey supports.	\$275.00

## PC SERIES

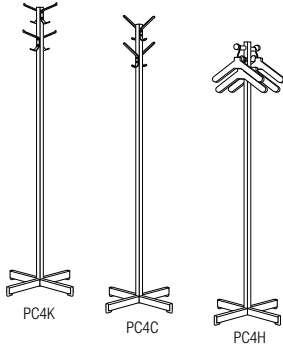

MODEL	H	W	D	SHIPPING WEIGHT	DESCRIPTION	COLOR/ FINISH	LIST PRICE
PC-4K	68 1/2"	21 1/2"	21 1/2"	9 lbs.	Hook style costumer	<b>Medium Grey, Sandstone, Black</b> with Stainless Steel Hooks	\$167.00
PC-4H	60"	21 1/2"	21 1/2"	11 lbs.	Hanger style costumer	Medium Grey, Sandstone, <b>Black</b> with Charcoal Grey Hangers	\$207.00
PC-4C	68 1/2"	21 1/2"	21 1/2"	9 lbs.	Hook style costumer with K21C hooks	Chrome	\$226.00

## EWC SERIES

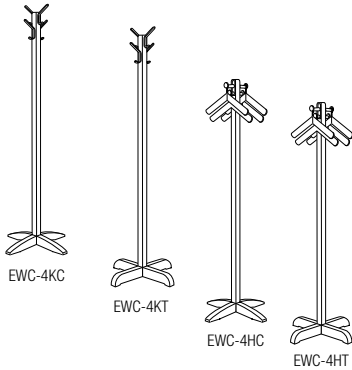

MODEL	H	W	D	SHIPPING WEIGHT	DESCRIPTION	COLOR/ FINISH	LIST PRICE
EWC-4KC	70 3/8"	24"	24"	15 lbs.	Wood costumer contemporary base	Oak, Mahogany, Victorian Cherry Hooks in Chrome, Bronze, Silver or Black	\$551.00
EWC-4KT	70 3/8"	24"	24"	15 lbs.	Wood costumer traditional base	Oak, Mahogany, Victorian Cherry Includes 4 matching hangers and polished chrome knobs	\$551.00
EWC-4HC	70 3/8"	24"	24"	15 lbs.	Wood costumer contemporary base	Oak, Mahogany, Victorian Cherry Includes 4 matching hangers and polished chrome knobs	\$665.00
EWC-4HT	70 3/8"	24"	24"	15 lbs.	Wood costumer traditional base	Oak, Mahogany, Victorian Cherry Includes 4 matching hangers and polished chrome knobs	\$665.00

## MARS+

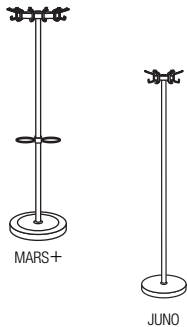

MODEL	H	W	D	SHIPPING WEIGHT	DESCRIPTION	COLOR/ FINISH	LIST PRICE
MARS+	68 1/2"	17 3/4"	17 3/4"	38 lbs.†	Textured metal, 12 Hooks w/umbrella stand	Black	\$1,065.00

## JUNO

MODEL	H	W	D	SHIPPING WEIGHT	DESCRIPTION	COLOR/ FINISH	LIST PRICE
JUNO	66 3/16"	13 13/16"	13 13/16"	22 lbs.	Textured metal, 6 Hooks	Black	\$615.00

## BAMBU

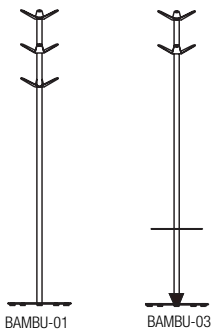

MODEL	H	W	D	SHIPPING WEIGHT	DESCRIPTION	COLOR/ FINISH	LIST PRICE
BAMBU-01	67 11/16"	14 3/4"	Ø	26 lbs.	Coat tree with painted aluminum post, painted steel base and 9 molded plastic hooks.	Grey Ral7022 post and base with Grey hooks, Grey White Ral 9002 post and base with White hooks or Green Ral 6000 post and base with Green hooks.	\$655.00
BAMBU-03	67 11/16"	14 3/4"	Ø	26 lbs.	Coat tree with painted aluminum post, painted steel base, umbrella holder and 6 molded plastic hooks.	Grey Ral7022 post and base with Grey hooks, Grey White Ral 9002 post and base with White hooks or Green Ral 6000 post and base with Green hooks.	\$730.00

† Ships via common carrier

**Bold** denotes quick ship  
See page 7 for details.



### ALOES MET

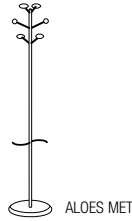

MODEL	H	W	D	SHIPPING WEIGHT	DESCRIPTION	COLOR/ FINISH	LIST PRICE
MET	67"	15"	Ø	20 lbs.	Coat tree with steel frame and 6 knobs in <b>Beech</b> , Wengue, White, Black, Yellow, Green, Blue, Purple or Red with umbrella retainer	Frame in <b>Black, Silver</b> , White, Sand, Chocolate or Green	\$395.00
MET JR	55 1/8"	13 3/8"	Ø	13 lbs.	Junior height coat tree with steel frame and 6 knobs in Beech, Wengue, White, Black, Yellow, Green, Blue, Purple or Red.	Frame in <b>Black, Silver</b> , White, Sand, Chocolate or Green	\$340.00

(See page 108 for matching hook strips and page 103 for matching magnetic hook.)

### XYLO

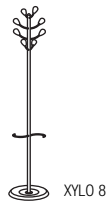

MODEL	H	W	D	SHIPPING WEIGHT	DESCRIPTION	COLOR/ FINISH	LIST PRICE
XYLO 4	67 1/2"	14 3/16"	Ø	12 lbs.	Coat tree with steel frame and 4 Beech knobs and umbrella retainer.	Black, Silver or White	\$310.00
XYLO 8	69 5/16"	14 3/16"	Ø	19 lbs.	Coat tree with steel frame and 8 Beech knobs and umbrella retainer.	Black, Silver or White	\$395.00

### KYOTO MKT

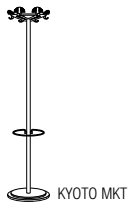

MODEL	H	W	D	SHIPPING WEIGHT	DESCRIPTION	COLOR/ FINISH	LIST PRICE
MKT	63"	13 1/2"	Ø	20 lbs.	Coat tree with steel post and padded cast iron base with 6 ABS plastic hooks.	<b>White, Silver or Black</b> frame with hooks in <b>Black, Blue, Red</b> , White, Silver or Anthracite	\$395.00

(See page 108 for matching hook strips and page 103 for matching magnetic hook.)

### MBT

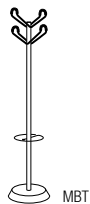

MODEL	H	W	D	SHIPPING WEIGHT	DESCRIPTION	COLOR/ FINISH	LIST PRICE
MBT	66"	15"	Ø	22 lbs. †	Coat tree with steel post and 4 coat hooks with umbrella holder.	White, <b>Black</b> or <b>Silver</b>	\$395.00

### YIN



MODEL	H	W	D	SHIPPING WEIGHT	DESCRIPTION	COLOR/ FINISH	LIST PRICE
YIN	62 1/2"	15 3/4"	Ø	15 lbs.	Metal coat tree with 6 hooks and umbrella stand.	Red, Black or White	\$385.00

(See page 108 for matching MYIW hook strips, page 103 for matching MYIM magnetic hooks and page 123 for matching umbrella stand.)

### KOBE



MODEL	H	W	D	SHIPPING WEIGHT	DESCRIPTION	COLOR/ FINISH	LIST PRICE
KOBE PP	64 1/4"	14 3/4"	Ø	20 lbs.	Metal coat tree with 6 ABS hooks and umbrella ring. Post color can be different than base, umbrella ring and hook support.	Post, base, umbrella ring and hook support in Silver, White, Black, Sand, Chocolate or Green. ABS hooks in White, Black, Silver or Red.	\$385.00

(See page 113 for matching hook strips and page 103 for matching magnetic hook.)

† Ships via common carrier

**Bold** denotes quick ship  
See page 7 for details.

### SAGITTA



MODEL	H	W	D	SHIPPING WEIGHT	DESCRIPTION	COLOR/FINISH	LIST PRICE
SAGITTA	66 15/16"	17 11/16"	Ø	14 lbs.	Coat tree with umbrella holder and 4 hangers in dark grey plastic.	Dark Grey with Satin Aluminum	\$775.00

### PALADINO



MODEL	H	W	D	SHIPPING WEIGHT	DESCRIPTION	COLOR/FINISH	LIST PRICE
PALADINO	68 1/2"	13 11/16"	Ø	12 lbs.	Coat tree in epoxy coated steel with round base and dark grey plastic hooks.	Dark Grey	\$385.00

### STICKS G+

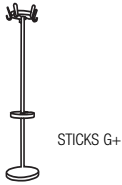

MODEL	H	W	D	SHIPPING WEIGHT	DESCRIPTION	COLOR/FINISH	LIST PRICE
STICKS G+	66 1/8"	13 13/16"	Ø	27 lbs.	Coat tree with plastic hat and coat hooks and umbrella holder in White.	Varnished Natural Oak post with crown, umbrella holder and base in White epoxy coated aluminum.	\$975.00

(See page 103 for matching magnetic hook and page 110 for matching hook strips.)

### PI COSTUMER



MODEL	H	W	D	SHIPPING WEIGHT	DESCRIPTION	COLOR/FINISH	LIST PRICE
PI (base is 13 3/8" x 13 3/8")	59"	18 1/8"	13 3/8"	16 lbs.	Steel coat stand with two hangers and beech accents	White, Black, Silver or Sand.	\$285.00

### MIRAC

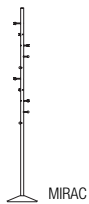

MODEL	H	W	D	SHIPPING WEIGHT	DESCRIPTION	COLOR/FINISH	LIST PRICE
MIRAC-10	75 3/8"	11 13/16"	11 13/16"	27 lbs.	Coat tree with 10 chrome knobs. Can be used with Mirac-6 plastic hangers.	Aluminum Ral 9006 or Black Grey Ral 7021 post and cast iron base.	\$835.00

(See page 110 for matching hook strip and page 104 for matching coat hook.)

### HULOT

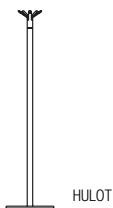

MODEL	H	W	D	SHIPPING WEIGHT	DESCRIPTION	COLOR/FINISH	LIST PRICE
HULOT	68 7/8"	18 7/8"	18 7/8"	26 lbs.	Coat tree with molded plastic hooks and cast iron base.	Grey White Ral 9002, Grey Ral 7022 or Beige Ral 1019	\$655.00

## TAIGA

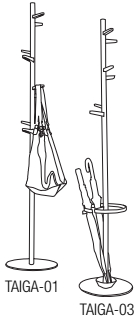

MODEL	H	W	D	SHIPPING WEIGHT	DESCRIPTION	COLOR/FINISH	LIST PRICE
TAIGA-01	69 3/4"	13 3/4"	Ø	26 lbs.	Coat tree with painted steel base, aluminum painted post and 8 plastic coat hooks. Can be used with Mirac-6 plastic hangers.	Grey White Ral 9002, Grey Ral 7022 or Turquoise Ral 6034	\$520.00
TAIGA-03	69 3/4"	13 3/4"	Ø	28 lbs.	Coat tree with painted steel base, aluminum painted post, umbrella ring and 6 plastic hooks. Can be used with Mirac-6 plastic hangers.	Grey White Ral 9002, Grey Ral 7022 or Turquoise Ral 6034	\$625.00

(See page 123 for matching umbrella stand.)

## HELIX



MODEL	H	W	D	SHIPPING WEIGHT	DESCRIPTION	COLOR/FINISH	LIST PRICE
HELIX-01	70"	12 3/4"	Ø	20 lbs.	Coat tree with painted steel base with 6 steel hooks and painted aluminum post.	Base and hooks in White Ral 9010, Textured Black Ral 9011 or Forge Gray, post in Anodized Aluminum or White Ral 9010 finish.	\$720.00

## HELIX-JR



MODEL	H	W	D	SHIPPING WEIGHT	DESCRIPTION	COLOR/FINISH	LIST PRICE
HELIX-JR	36 5/8"	8 9/16"	8 9/16"	10 lbs.	Junior height unit for coat/purse/bag with painted steel base, 3 painted hooks and painted aluminum post.	Base and hooks in White Ral 9010 or Forge Gray, post in Anodized Aluminum or White Ral 9010 finish.	\$425.00

## BRANCH

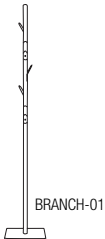

MODEL	H	W	D	SHIPPING WEIGHT	DESCRIPTION	COLOR/FINISH	LIST PRICE
BRANCH-01	74 7/8"	12 7/8"	Ø	23 lbs.	Coat tree with 5 painted steel hooks, square base and painted aluminum post.	Base and hooks in White Ral 9010, Textured Black Ral 9011 or Forge Gray, post in Anodized Aluminum or White Ral 9010 finish.	\$675.00

## SECOND TREE

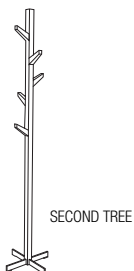

MODEL	H	W	D	SHIPPING WEIGHT	DESCRIPTION	COLOR/FINISH	LIST PRICE
SECOND TREE	74 3/4"	15"	Ø	19 lbs.	Painted steel coat tree with five oak wood hooks.	Black Ral 9011, Forge Grey or White Ral 9010 with Oak wood hooks.	\$1,097.00

## DS SERIES

### HANGER STYLE

MODEL	H	W	D	SHIPPING WEIGHT	DESCRIPTION	COLOR/FINISH	LIST PRICE
-------	---	---	---	-----------------	-------------	--------------	------------

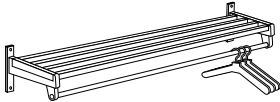

DS-2H, DS-3H, DS-4H

DS-2H	6 1/2"	24"	11 1/2"	8 lbs.	All powder-coated steel rack with nickel chrome plated 1" hanger bar.	<b>Medium Grey</b> Sandstone <b>Black</b> Lunar White Bronze Metallic	\$163.00
DS-3H	6 1/2"	36"	11 1/2"	11 lbs.			\$196.00
DS-4H	6 1/2"	48"	11 1/2"	13 lbs.			\$226.00
DS-5H	6 1/2"	60"	11 1/2"	15 lbs.			\$260.00
DS-6H	6 1/2"	72"	11 1/2"	17 lbs.			\$301.00
Capacity—5 hangers per foot.							

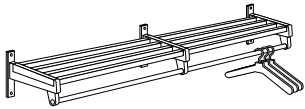

DS-5H/DS-6H

DS-2HA	6 1/2"	24"	11 1/2"	6 lbs.	Powder-coated steel brackets with clear anodized aluminum shelf tubes and a nickel chrome plated 1" hanger bar.	<b>Medium Grey</b> Sandstone <b>Black</b> Lunar White Bronze Metallic	\$174.00
DS-3HA	6 1/2"	36"	11 1/2"	9 lbs.			\$203.00
DS-4HA	6 1/2"	48"	11 1/2"	10 lbs.			\$226.00
DS-5HA	6 1/2"	60"	11 1/2"	13 lbs.			\$296.00
DS-6HA	6 1/2"	72"	11 1/2"	15 lbs.			\$331.00
Capacity—5 hangers per foot.							

DS-H units accept standard 1-1/2" open hook hangers, CL closed loop hangers or R1.5 receptacle with PP or ball top hangers.

DS-2HO	6 1/2"	24"	11 1/2"	6 lbs.	Powder-coated steel brackets with natural oak shelf tubes and a nickel chrome plated 1" hanger bar.	Medium Grey Sandstone <b>Black</b> Lunar White Bronze Metallic	\$174.00
DS-3HO	6 1/2"	36"	11 1/2"	9 lbs.			\$244.00
DS-4HO	6 1/2"	48"	11 1/2"	10 lbs.			\$272.00
DS-5HO	6 1/2"	60"	11 1/2"	13 lbs.			\$365.00
DS-6HO	6 1/2"	72"	11 1/2"	15 lbs.			\$389.00
Capacity—5 hangers per foot.							

### HOOK STYLE

MODEL	H	W	D	SHIPPING WEIGHT	DESCRIPTION	COLOR/FINISH	LIST PRICE
-------	---	---	---	-----------------	-------------	--------------	------------

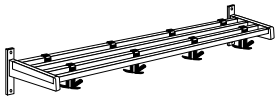

DS-2K, DS-3K, DS-4K

DS-2K	6 1/2"	24"	11 1/2"	8 lbs.	All powder-coated steel rack with Charcoal Grey K-73 powder coated triple prong hooks. 2K has 4 hooks, 3K has 6 hooks, 4K has 8 hooks, 5K has 12 hooks, 6K has 16 hooks.	Medium Grey Sandstone <b>Black</b> Lunar White Bronze Metallic	\$174.00
DS-3K	6 1/2"	36"	11 1/2"	10 lbs.			\$203.00
DS-4K	6 1/2"	48"	11 1/2"	12 lbs.			\$243.00
DS-5K	6 1/2"	60"	11 1/2"	14 lbs.			\$285.00
DS-6K	6 1/2"	72"	11 1/2"	16 lbs.			\$342.00
Capacity—5 hangers per foot.							

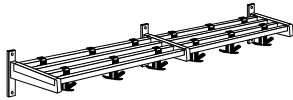

DS-5K/DS-6K

DS-2KA	6 1/2"	24"	11 1/2"	6 lbs.	Powder-coated steel brackets with clear anodized aluminum shelf tubes and Charcoal Grey K-73 powder coated triple prong hooks. 2KA has 4 hooks, 3KA has 6 hooks, 4KA has 8 hooks, 5KA has 12 hooks, 6KA has 16 hooks.	Medium Grey Sandstone <b>Black</b> Lunar White Bronze Metallic	\$192.00
DS-3KA	6 1/2"	36"	11 1/2"	7 lbs.			\$226.00
DS-4KA	6 1/2"	48"	11 1/2"	8 lbs.			\$260.00
DS-5KA	6 1/2"	60"	11 1/2"	12 lbs.			\$301.00
DS-6KA	6 1/2"	72"	11 1/2"	14 lbs.			\$389.00
Capacity—5 hangers per foot.							

### UTILITY STYLE

MODEL	H	W	D	SHIPPING WEIGHT	DESCRIPTION	COLOR/FINISH	LIST PRICE
-------	---	---	---	-----------------	-------------	--------------	------------

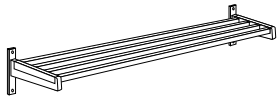

DS-2U, DS-3U, DS-4U

DS-2U	6 1/2"	24"	11 1/2"	6 lbs.	All powder-coated steel rack.	Medium Grey Sandstone <b>Black</b> Lunar White Bronze Metallic	\$117.00
DS-3U	6 1/2"	36"	11 1/2"	8 lbs.			\$151.00
DS-4U	6 1/2"	48"	11 1/2"	10 lbs.			\$197.00
DS-5U	6 1/2"	60"	11 1/2"	12 lbs.			\$221.00
DS-6U	6 1/2"	72"	11 1/2"	15 lbs.			\$244.00
Capacity—5 hangers per foot.							

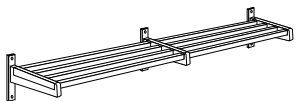

DS-5U/DS-6U

DS-2UA	6 1/2"	24"	11 1/2"	4 lbs.	Powder-coated steel brackets with clear anodized aluminum shelf tubes.	Medium Grey Sandstone <b>Black</b> Lunar White Bronze Metallic	\$133.00
DS-3UA	6 1/2"	36"	11 1/2"	5 lbs.			\$174.00
DS-4UA	6 1/2"	48"	11 1/2"	6 lbs.			\$214.00
DS-5UA	6 1/2"	60"	11 1/2"	11 lbs.			\$260.00
DS-6UA	6 1/2"	72"	11 1/2"	14 lbs.			\$278.00
Capacity—5 hangers per foot.							

DS-2UO	6 1/2"	24"	11 1/2"	4 lbs.	Powder-coated steel brackets with natural oak shelf tubes.	Medium Grey Sandstone <b>Black</b> Lunar White Bronze Metallic	\$151.00
DS-3UO	6 1/2"	36"	11 1/2"	5 lbs.			\$186.00
DS-4UO	6 1/2"	48"	11 1/2"	6 lbs.			\$227.00
DS-5UO	6 1/2"	60"	11 1/2"	11 lbs.			\$285.00
DS-6UO	6 1/2"	72"	11 1/2"	14 lbs.			\$342.00
Capacity—5 hangers per foot.							

**Bold** denotes quick ship  
See page 7 for details.

## ARNAGE

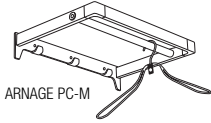

ARNAGE PC-M

MODEL	H	W	D	SHIPPING WEIGHT	DESCRIPTION	COLOR/FINISH	LIST PRICE
ARNAGE PC-M	1 1/2"	20 1/16"	14"	8 lbs.	Steel wall mounted coat rack with hanger rod	White, Black, Sand or Silver	\$355.00

## TERTIO W/K

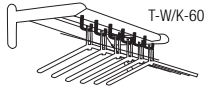

T-W/K-60

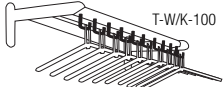

T-W/K-100

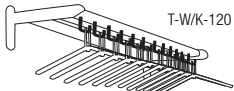

T-W/K-120

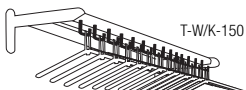

T-W/K-150

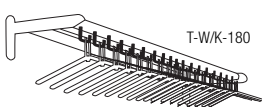

T-W/K-180

MODEL	H	W	D	SHIPPING WEIGHT	DESCRIPTION	COLOR/FINISH	LIST PRICE
T-W/K-60	11 13/16"	23 5/8"	21 1/4"	7 lbs.	Wall rack with powder coated brackets and satin anodized aluminum shelf. Includes 6 hangers	Dark Grey with Satin Aluminum	\$575.00
T-W/K-100	11 13/16"	39 3/8"	21 1/4"	12 lbs.	Wall rack with powder coated brackets and satin anodized aluminum shelf. Includes 10 hangers	Dark Grey with Satin Aluminum	\$815.00
T-W/K-120	11 13/16"	47 1/4"	21 1/4"	14 lbs.	Wall rack with powder coated brackets and satin anodized aluminum shelf. Includes 12 hangers	Dark Grey with Satin Aluminum	\$940.00
T-W/K-150	11 13/16"	59 1/16"	21 1/4"	17 lbs.	Wall rack with powder coated brackets and satin anodized aluminum shelf. Includes 14 hangers	Dark Grey with Satin Aluminum	\$1,225.00
T-W/K-180	11 13/16"	70 7/8"	21 1/4"	21 lbs.	Wall rack with powder coated brackets and satin anodized aluminum shelf. Includes 18 hangers	Dark Grey with Satin Aluminum	\$1,395.00

## TERTIO W2

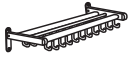

T-W2-60

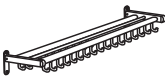

T-W2-90

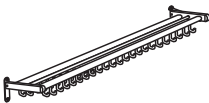

T-W2-120

MODEL	H	W	D	SHIPPING WEIGHT	DESCRIPTION	COLOR/FINISH	LIST PRICE
T-W2-60	6 5/16"	23 5/8"	13"	7 lbs.	Hook style wall rack with powder coated brackets and satin anodized aluminum shelf. Includes 11 dark grey plastic hooks.	Dark Grey with Satin Aluminum	\$455.00
T-W2-90	6 5/16"	35 7/16"	13"	10 lbs.	Hook style wall rack with powder coated brackets and satin anodized aluminum shelf. Includes 17 dark grey plastic hooks.	Dark Grey with Satin Aluminum	\$595.00
T-W2-120	6 5/16"	47 1/4"	13"	14 lbs.	Hook style wall rack with powder coated brackets and satin anodized aluminum shelf. Includes 23 dark grey plastic hooks.	Dark Grey with Satin Aluminum	\$730.00

## CLM SERIES

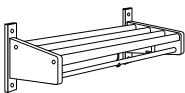

CLM-2

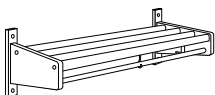

CLM-3



CLM-4

MODEL	H	W	D	SHIPPING WEIGHT	DESCRIPTION	COLOR/FINISH	LIST PRICE
CLM-2	12 3/4"	24"	12 1/2"	7 lbs	Stained Natural Hardwood with oval shelf slats and 5/8" diameter hanger bar 2' in width	<b>Victorian Cherry</b> <b>Mahogany</b> Natural Maple*	\$230.00
CLM-3	12 3/4"	36"	12 1/2"	8 lbs	Stained Natural Hardwood with oval shelf slats and 5/8" diameter hanger bar 3' in width	<b>Victorian Cherry</b> <b>Mahogany</b> Natural Maple*	\$248.00
CLM-4	12 3/4"	48"	12 1/2"	9 lbs	Stained Natural Hardwood with oval shelf slats and 5/8" diameter hanger bar 4' in width	<b>Victorian Cherry</b> <b>Mahogany</b> Natural Maple*	\$266.00

**CLM units accept 5/8" mini hook hangers or standard 1-1/2" open hook hangers. Capacity-5 hangers per foot.**  
\* Natural Maple finish will have some variation in wood grain.

**Bold** denotes quick ship  
See page 7 for details.

## LINEA

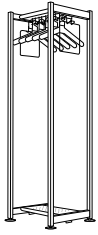

LINEA-PR



MODEL	H	W	D	SHIPPING WEIGHT	DESCRIPTION	COLOR/FINISH	LIST PRICE
LINEA-PR	66"	17"	17"	40 lbs	Personal rack with hat & boot shelf, umbrella holders/5 MG17PM hangers	<b>Black/ Black Hangers</b>	\$509.00
LINEA-3	66"	36"	17"	50 lbs	3 ft. rack with hat & boot shelf, umbrella holders/12 MG17PM hangers	<b>Black/ Black Hangers</b>	\$551.00
LINEA-4	66"	48"	17"	56 lbs	4 ft. rack with hat & boot shelf, umbrella holders/16 MG17PM hangers	<b>Black/ Black Hangers</b>	\$572.00

Linea can be used with CST 4 casters.

## OFFICE RAK™

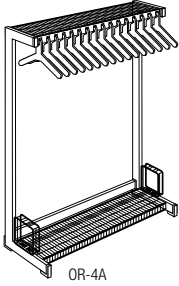

OR-4A

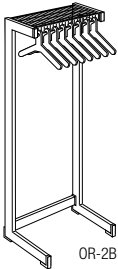

OR-2B

MODEL	H	W	D	SHIPPING WEIGHT	DESCRIPTION	COLOR/FINISH	LIST PRICE
OR-2A	60"	24"	18"	40 lbs	8 Hangers/Hanger Spacer/1 Hat, 1 Boot Shelf/2 Umbrella Holders	<b>Black Medium Grey Sandstone</b>	\$585.00
OR-3A	60"	36"	18"	45 lbs	12 Hangers/Hanger Spacer/1 Hat, 1 Boot Shelf/2 Umbrella Holders	<b>Black Medium Grey Sandstone</b>	\$631.00
OR-4A	60"	48"	18"	51 lbs	16 Hangers/Hanger Spacer/1 Hat, 1 Boot Shelf/2 Umbrella Holders	<b>Black Medium Grey Sandstone</b>	\$665.00
OR-2B	60"	24"	18"	33 lbs	8 Hangers/1 Hat Shelf	<b>Black Medium Grey Sandstone</b>	\$438.00
OR-3B	60"	36"	18"	35 lbs	12 Hangers/1 Hat Shelf	<b>Black Medium Grey Sandstone</b>	\$471.00
OR-4B	60"	48"	18"	40 lbs	16 Hangers/1 Hat Shelf	<b>Black Medium Grey Sandstone</b>	\$518.00

Office Rak can be adapted for use with CST4 casters.  
Office Rak is standard with MG17PM charcoal grey hangers.

## RAP RAK™

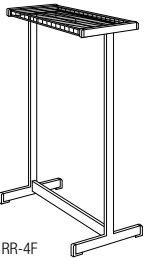

RR-4F

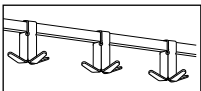

KSF



CST-4



CST-4RE

MODEL	H	W	D	SHIPPING WEIGHT	DESCRIPTION	COLOR/FINISH	LIST PRICE
RR-4F	60"	48"	23"	39 lbs	Double Sided Floor Rack Hanger capacity 40-48 coats or use with KSF-4	<b>Black Medium Grey Sandstone</b>	\$557.00
RR-4FC	60"	48"	23"	39 lbs	Heavy Duty Double Sided Floor Rack- Chrome Plated/Black Shelf/upper and lower spacer bars	Chrome with Black Shelf	\$671.00
RR-4J	48"	48"	23"	39 lbs	Double Sided Floor Rack-Junior Height Hanger capacity 40-48 coats or use with KSF-4	Black Medium Grey Sandstone	\$557.00
KSF-4	3 1/4"	46"	2 1/2"	9 lbs	Two 4 ft. Hook Rails with 10 K-73 Triple Prong Hooks-30 capacity for use with RR-4F or RR-4J only	Medium Grey, Black or Sandstone Rail w/Charcoal Grey Hooks	\$135.00
CST-4	2 1/2"			3 lbs	Set of 4 Double wheel locking furniture casters. Add 2 1/2" to height of rack. For use with OR, RR and Designer Series* style racks	<b>Black</b>	\$48.00
CST-4RE	4"			5 lbs	Set of 4 Heavy Duty 4" locking casters. Add 4" to height of rack. For use with RR and DDF style racks only. (Caster base assembly still required for DDF)	Black	\$113.00

Rap Rak units accept theft deterrent MG17PM hangers or any standard 1-1/2" open hook or 5/8" mini hook hangers.

\*Designer Series racks require use of CBA caster base assembly which includes CST4 2" casters.

**Bold** denotes quick ship. See page 7 for details.

## DS SERIES

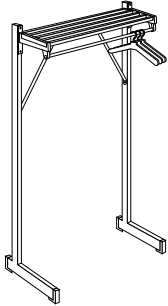

DSF-3H

Note: Hangers sold separately

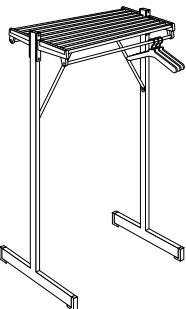

DDF-3H

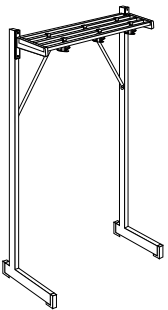

DSF-3K

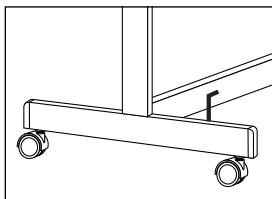

CBA

MODEL	H	W	D	SHIPPING WEIGHT	DESCRIPTION	COLOR/FINISH	LIST PRICE
<b>DSF-3H</b>	61"	36"	18 3/8"	36 lbs	Hanger Style Single Sided Floor Rack-All powder-coated steel construction with 1" nickel chrome hanger bar Capacity-5 hangers per foot.	<b>Medium Grey</b> Sandstone <b>Black</b>	\$446.00
<b>DSF-4H</b>	61"	48"	18 3/8"	40 lbs			\$476.00
<b>*DSF-5H</b>	61"	60"	18 3/8"	45 lbs			\$516.00
DSF-3HA	61"	36"	18 3/8"	36 lbs	Hanger Style Single Sided Floor Rack- Powder-coated steel construction with clear anodized aluminum shelf bars and 1" nickel chrome hanger bar Capacity-5 hangers per foot.	Medium Grey, Sandstone or Black frames each with Aluminum Shelf Tubes	\$504.00
DSF-4HA	61"	48"	18 3/8"	40 lbs			\$544.00
<b>*DSF-5HA</b>	61"	60"	18 3/8"	45 lbs			\$591.00
DDF-3H	61"	36"	27 3/8"	47 lbs †	Hanger Style Double Sided Floor Rack- All powder-coated steel construction with 1" nickel chrome hanger bar Capacity-5 hangers per foot.	Medium Grey Sandstone Black	\$689.00
DDF-4H	61"	48"	27 3/8"	53 lbs †			\$735.00
<b>*DDF-5H</b>	61"	60"	27 3/8"	59 lbs †			\$793.00
DDF-3HA	61"	36"	27 3/8"	47 lbs †	Hanger Style Double Sided Floor Rack- Powder-coated steel construction with clear anodized aluminum shelf bars and 1" nickel chrome hanger bar Capacity-5 hangers per foot.	Medium Grey, Sandstone or Black frames each with Aluminum Shelf Tubes	\$793.00
DDF-4HA	61"	48"	27 3/8"	53 lbs †			\$852.00
<b>*DDF-5HA</b>	61"	60"	27 3/8"	59 lbs †			\$909.00
DSF-3K	61"	36"	18 3/8"	38 lbs	Hook Style Single Sided Floor Rack-All powder-coated steel construction with Charcoal Grey K-73 triple prong hooks. 3K has 6 hooks, 4K has 8 hooks, 5K has 12 hooks	Medium Grey Sandstone Black each with Charcoal Grey K-73 Hooks	\$498.00
DSF-4K	61"	48"	18 3/8"	42 lbs			\$527.00
DSF-5K	61"	60"	18 3/8"	47 lbs			\$568.00
DSF-3KA	61"	36"	18 3/8"	38 lbs	Hook Style Single Sided Floor Rack- Powder-coated steel construction with clear anodized aluminum shelf bars and Charcoal Grey K-73 triple prong hooks. 3KA has 6 hooks, 4KA has 8 hooks, 5KA has 12 hooks	Medium Grey, Sandstone or Black frames each with Aluminum Shelf Tubes and Charcoal Grey K-73 Hooks	\$568.00
DSF-4KA	61"	48"	18 3/8"	42 lbs			\$608.00
DSF-5KA	61"	60"	18 3/8"	47 lbs			\$654.00
CBA-36	Add 3" to height of rack	34"	N/A	9 lbs.	Set of 4-2 1/2" Double wheel locking casters with Spacer Bar and Shock Bracing. For Models DSF-3 and DDF-3 use CBA-36. For Models DSF-4 and DDF-4 use CBA-48. For Models DSF-5 and DDF-5 use Model CBA-60. <i>Specify whether a Single (DSF) or Double (DDF) is needed.</i>	Medium Grey Sandstone Black with Black Casters	\$123.00
CBA-48	Add 3" to height of rack	46"	N/A	10 lbs.			\$131.00
CBA-60	Add 3" to height of rack	58"	N/A	11 lbs.			\$140.00

**Hanger style units accept standard 1-1/2" open hangers, CL closed loop hangers or R1.5 receptacles with MG17PP T-Top or MG17B ball top hangers.**

**\*A maximum of 5 hangers per foot are recommended on all DS Series floor racks. Some hanger bar deflection is possible on 5ft. units.**

† Ships via common carrier

**Bold** denotes quick ship  
See page 7 for details.

## TERTIO

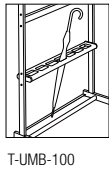
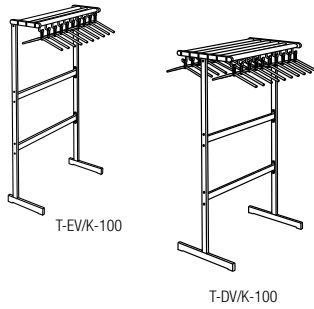

MODEL	H	W	D	SHIPPING WEIGHT	DESCRIPTION	COLOR/ FINISH	LIST PRICE
T-EV/K-100	66 15/16"	39 3/8"	23 5/8"	39 lbs. †	Single Sided Floor Rack- Powder-coated frames with satin anodized aluminum shelf, includes 10 hangers	Dark Grey with Satin Aluminum	\$1,720.00
T-DV/K-100	66 15/16"	39 3/8"	40 3/16"	47 lbs. †	Double Sided Floor Rack- Powder-coated frames with satin anodized aluminum shelf, includes 20 hangers	Dark Grey with Satin Aluminum	\$2,375.00
T-UMB-100	19 11/16"	39 3/8"	5 9/16"	15 lbs.	Umbrella Stand which integrates into the EV model complete with driptray and rubber mat.	Satin Anodized Aluminum	\$540.00

## MEGA RAK™

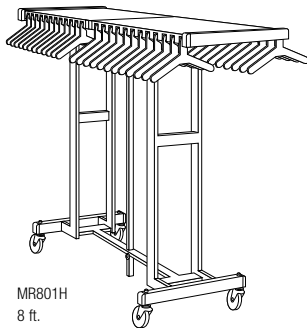

MR801H  
8 ft.

Note: Hangers sold separately

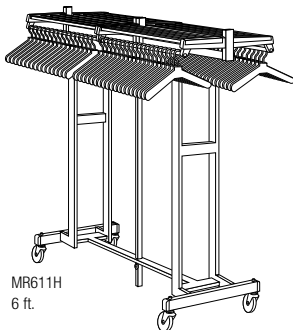

MR611H  
6 ft.

MODEL	H	W	D	SHIPPING WEIGHT	DESCRIPTION	COLOR/ FINISH	LIST PRICE
MR-801H	81" Closed 60" Open	25"	18" Closed 97" Open	99 lbs. †	Hanger style folding rack with wire grid shelves on 4" ball bearing locking casters. Holds up to 100 coats.  Use with MG17PM, any 1-1/2" open hook or mini hook hangers.	Charcoal Grey Frame with Medium Grey Shelf	\$1,600.00
MR-801K	81" Closed 60" Open	25"	18" Closed 97" Open	125 lbs. †	Hook style folding rack with wire grid shelves on 4" ball bearing locking casters. Comes complete with 48 K-73 triple prong hooks, capacity 144 coats	Charcoal Grey Frame with Medium Grey Shelf	\$1,806.00
MR-611H	81" Closed 62" Open	25"	18" Closed 72" Open	107 lbs. †	Hanger style folding rack with 1" Ni-Chrome hanger bars on 4" ball bearing locking casters. Holds up to 72 coats.  Use with MG17PH or any standard 1-1/2" open hook hanger.	Black	\$1,485.00
MR-611K	81" Closed 62" Open	25"	18" Closed 72" Open	120 lbs. †	Hook style folding rack, on 4" ball bearing locking casters. Comes complete with 40 K-73 triple prong hooks, capacity 120 coats.	Black	\$1,600.00
MR-UMB	10"	10"	3"	5 lbs.	Set of 2 umbrella holders which attach to the frame capacity 6 umbrellas	Charcoal Grey	\$65.00
MR-HC	N/A				Set of 4 hooks to store hangers on Mega Rak. Must be used with MG170HN hangers only. Must be ordered at same time as Mega Rak unit.	Chrome	\$49.00

**Junior height available for all Mega Rak models. Specify "Junior Height" on purchase order. Additional charge of \$79.00 net per unit applies.**

Please contact us for information on coat checks.

† Ships via common carrier



## SHERLO

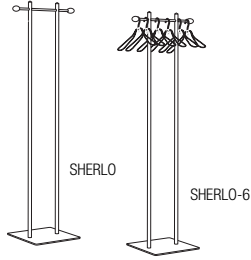

MODEL	H	W	D	SHIPPING WEIGHT	DESCRIPTION	COLOR/ FINISH	LIST PRICE
SHERLO	67 5/16"	21 5/8"	15 3/4"	30 lbs. †	Steel coat stand with square base and hanger bar with wood accents.	Stand in White, Black, Silver and Sand. Wood accents in Beech.	\$695.00
SHERLO-6	67 5/16"	21 5/8"	15 3/4"	33 lbs. †	Steel coat stand with six Filo-S hangers and hanger bar with wood accents	Stand and hangers in White, Black, Silver and Sand. Wood accents in Beech.	\$865.00

## ARNAGE

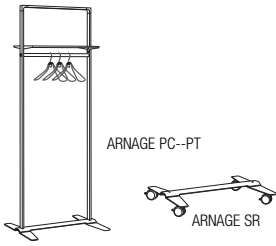

MODEL	H	W	D	SHIPPING WEIGHT	DESCRIPTION	COLOR/ FINISH	LIST PRICE
ARNAGE PC-P	66 15/16"	28 3/16"	21 5/8"	35 lbs. †	Steel floor rack with hanger rod	White, Black, Silver or Sand.	\$695.00
ARNAGE PC-PT	72 1/4"	28 3/16"	21 5/8"	40 lbs. †	Steel floor rack with hanger rod and shelf	White, Black Silver or Sand.	\$845.00
ARNAGE SR	3"	28 3/16"	21 5/8"	10 lbs.	Optional castor base for use on PC-P and PC-PT units	White, Black, Silver or Sand.	\$210.00

## MIRAC

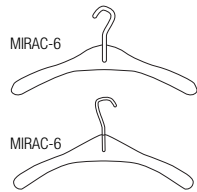

MODEL	H	W	D	SHIPPING WEIGHT	DESCRIPTION	COLOR/ FINISH	LIST PRICE
MIRAC-6	1"	19 11/16"	3"	4 lbs.	Plastic coat hanger, carton of 6 each.	Transparent	\$130.00
MIRAC-6	1"	19 11/16"	3"	4 lbs.	Plastic coat hanger, carton of 6 each.	Transparent	\$130.00

## FILO

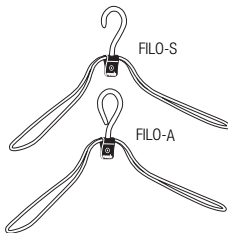

MODEL	H	W	D	SHIPPING WEIGHT	DESCRIPTION	COLOR/ FINISH	LIST PRICE
FILO-S	9 7/16"	17 5/16"	2 3/8"	1 lb.	Epoxy coated wire open hook hanger	White, Black, Silver or Sand	\$30.00
FILO-A	9 7/16"	17 5/16"	2 3/8"	1 lb.	Epoxy coated wire theft deterrent closed loop hanger	White, Black, Silver or Sand	\$30.00

## PI

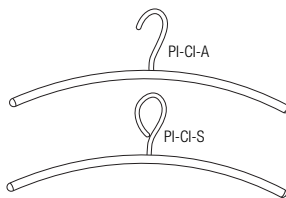

MODEL	H	W	D	SHIPPING WEIGHT	DESCRIPTION	COLOR/ FINISH	LIST PRICE
PI-CI-S	5 3/8"	18 1/8"	9/16"	1 lb.	Steel open hook hanger with beech ends	White, Black, Silver or Sand	\$45.00
PI-CI-A	5 3/8"	18 1/8"	9/16"	1 lb.	Steel anti-theft closed loop hanger with beech ends	White, Black, Silver or Sand	\$45.00

## STEEL HANGERS

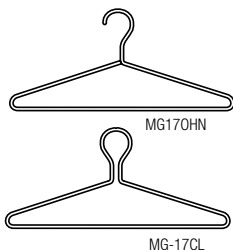

MODEL	H	W	D	SHIPPING WEIGHT	DESCRIPTION	COLOR/ FINISH	LIST PRICE
MG-170HN	7 5/8"	17"	1/8"	1/4 lb. 18 lbs.	Wire open open hook 1 ea Wire open open hook 50 pk	<b>Bright Ni Chromium</b>	\$11.00 \$310.00
MG-17CL	7 5/8"	17"	1/8"	1/4 lb. 18 lbs.	Wire closed loop hanger 1 ea Wire closed loop hanger 50 pk	<b>Bright Ni Chromium</b>	\$11.00 \$310.00

**Bold** denotes quick ship. See page 7 for details

## MOLDED POLYSTYRENE HANGERS

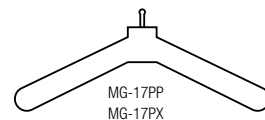
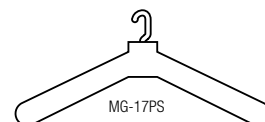
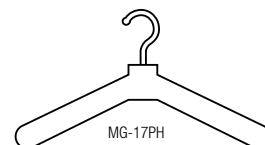
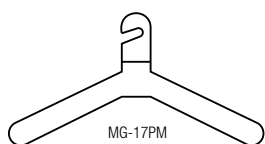

MODEL	H	W	D	SHIPPING WEIGHT	DESCRIPTION	COLOR/ FINISH	LIST PRICE
MG-17PM	8 7/8"	17"	3/4"	1/4 lb.	Slotted plastic anti-theft design 1 ea	<b>Black, Charcoal Grey</b>	\$13.00
				3 lbs.	Slotted plastic anti-theft design 6 pk		\$50.00
				8 lbs.	Slotted plastic anti-theft design 24 pk		\$146.00
				30 lbs.	Slotted plastic anti-theft design 100 pk		\$552.00
MG-17PH	9"	17"	3/4"	1/4 lb.	Open hook polystyrene 1 ea	<b>Black, Charcoal Grey</b>	\$13.00
				3 lbs.	Open hook polystyrene 6 pk		\$50.00
				8 lbs.	Open hook polystyrene 24 pk		\$146.00
				30 lbs.	Open hook polystyrene 100 pk		\$552.00
MG-17PS	7 7/8"	17"	3/4"	1/4 lb.	Mini hook polystyrene 1 ea	Black, Charcoal Grey	\$13.00
				3 lbs.	Mini hook polystyrene 6 pk		\$50.00
				8 lbs.	Mini hook polystyrene 24 pk		\$146.00
				30 lbs.	Mini hook polystyrene 100 pk		\$552.00
MG-17PX (Use with R34)	6 7/8"	17"	3/4"	1/4 lb.	T-top polystyrene 1 ea	Black, Charcoal Grey	\$13.00
				8 lbs.	T-top polystyrene 24 pk		\$146.00
				30 lbs.	T-top polystyrene 100 pk		\$552.00
MG-17PP (Use with R1.5)	6 7/8"	17"	3/4"	1/4 lb.	T-top polystyrene 1 ea	Black, Charcoal Grey	\$13.00
				8 lbs.	T-top polystyrene 24 pk		\$146.00
				30 lbs.	T-top polystyrene 100 pk		\$552.00

## WOOD HANGERS

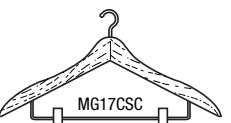
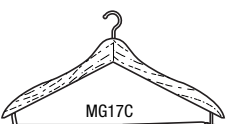
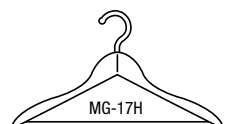
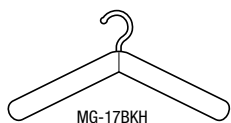
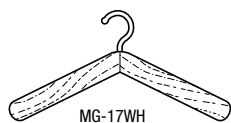

MODEL	H	W	D	SHIPPING WEIGHT	DESCRIPTION	COLOR/ FINISH	LIST PRICE
MG-17WS* & WH**				1/4 lb.	Solid wood open hook hanger 1 ea		\$24.00
MG-17OS & OH	8 3/4"	17"	3/8"	3 lbs.	Solid wood open hook hanger 6 pk	Walnut, Oak, Mahogany, Victorian Cherry	\$123.00
MG-17MS & MH				9 lbs.	Solid wood open hook hanger 24 pk		\$476.00
MG-17CHS & CH				37 lbs.	Solid wood open hook hanger 100 pk		\$1,960.00
MG-17BKS* & BKH**	8 3/4"	17"	3/8"	1/4 lb.	Solid wood open hook hanger 1 ea	Black Sandstone	\$24.00
				3 lbs.	Solid wood open hook hanger 6 pk		\$123.00
				9 lbs.	Solid wood open hook hanger 24 pk		\$476.00
MG-17H	9 1/2"	17"	5/8"	37 lbs.	Solid wood open hook hanger 100 pk	<b>Light Hardwood</b>	\$1,960.00
				1/4 lb.	Open hook hardwood 1 ea		\$11.00
				9 lbs.	Open hook hardwood 24 pk		\$127.00
MG-17B	8 7/8"	17"	5/8"	41 lbs.	Open hook hardwood 100 pk	Light Hardwood	\$501.00
				1/4 lb.	Ball-top hardwood 1 ea		\$11.00
				9 lbs.	Ball-top hardwood 24 pk		\$127.00
MG-17C	9 3/4"	17"	3 3/4"	41 lbs.	Ball-top hardwood 100 pk	Natural or Dark Stain	\$501.00
				1/2 lb.	Contoured w/locking trouser bar with mini hook		\$8.00
MG-17CSC	10 3/16"	17"	3 3/4"	1/2 lb.	Contoured w/skirt clips with mini hook	Natural or Dark Stain	\$9.00

\* S indicates 5/8" mini hook.  
\*\* H indicates standard 1 1/2" open hook.

## HANGER RECEPTACLES

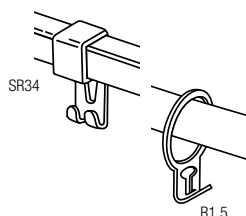

MODEL	H	W	D	SHIPPING WEIGHT	DESCRIPTION	COLOR/ FINISH	LIST PRICE
SR34	2 3/16"	7/8"	7/8"	1/4 lb.	Receptacle for 3/4" square tube	Black or Charcoal Grey	\$8.00
R1.5	2 1/2"	1 15/16"	1/2"	1/4 lb.	Receptacle for 1 1/4" O.D. hanger rod	Plated steel	\$6.00

**Bold** denotes quick ship  
See page 7 for details

P 70 / P 100

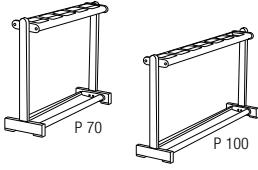

MODEL	H	W	D	SHIPPING WEIGHT	DESCRIPTION	COLOR/ FINISH	LIST PRICE
P 70	20 7/8"	27 9/16"	8 11/16"	14 lbs.	Umbrella stand for up to 15 umbrellas	Dark Grey w/Satin Aluminum	\$615.00
P 100	20 7/8"	39 3/8"	8 11/16"	16 lbs.	Umbrella stand for up to 20 umbrellas	Dark Grey w/Satin Aluminum	\$645.00

BAYU 2

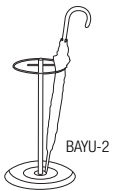

MODEL	H	W	D	SHIPPING WEIGHT	DESCRIPTION	COLOR/ FINISH	LIST PRICE
BAYU-2	23 5/8"	14 3/16"	Ø	9 lbs.	Steel umbrella stand	White, Black or Silver	\$220.00

YIN

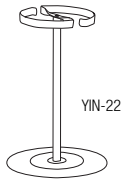

MODEL	H	W	D	SHIPPING WEIGHT	DESCRIPTION	COLOR/ FINISH	LIST PRICE
YIN-22	19 3/4"	15 3/4"	15 3/4"	12 lbs.	Steel umbrella stand.	Red, Black or White	\$220.00

(See page 113 for matching coat tree, page 103 for magnetic hook and page 108 for matching hook strips.)

RIGA

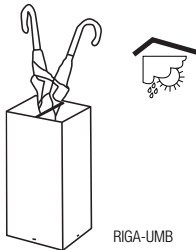

MODEL	H	W	D	SHIPPING WEIGHT	DESCRIPTION	COLOR/ FINISH	LIST PRICE
RIGA-UMB	19 5/16"	9 13/16"	9 13/16"	10 lbs.	Umbrella stand with four sections for umbrellas and non-skid grid on bottom to hold umbrellas in place.	Stainless Steel with Black ABS base.	\$510.00
RIGA-UMB-P	19 5/16"	9 13/16"	9 13/16"	10 lbs.	Umbrella stand with four sections for umbrellas and non-skid grid on bottom to hold umbrellas in place.	Grey White Ral 9002 with Black ABS base.	\$395.00

Stainless finish suitable for outdoor use under cover. White is indoor only.

(See page 36 & 37 for matching waste receptacles.)

TAIGA

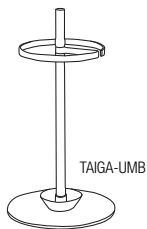

MODEL	H	W	D	SHIPPING WEIGHT	DESCRIPTION	COLOR/ FINISH	LIST PRICE
TAIGA-UMB	26"	13 3/4"	Ø	18 lbs.	Umbrella stand with painted steel base and aluminum painted tube.	Grey White Ral 9002, Turquoise Ral 6034 or Grey Ral 7022.	\$485.00

(See page 115 for matching coat tree.)

### SILO



SP-2550

MODEL	H	W	D	SHIPPING WEIGHT	DESCRIPTION	COLOR/ FINISH	LIST PRICE
SP-2550	19 11/16"	9 13/16"	Ø	8 lbs.	Umbrella stand with drip tray in epoxy coated steel.	Black, White or Grey Metallic	\$265.00
SP-2550-SS	19 11/16"	9 13/16"	Ø	7 lbs.	Umbrella stand with drip tray.	Brushed Stainless Steel	\$395.00

### DRIP

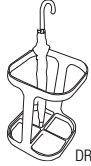

DRIP

MODEL	H	W	D	SHIPPING WEIGHT	DESCRIPTION	COLOR/ FINISH	LIST PRICE
DRIP	17 11/16"	12 3/8"	Ø	14 lbs.	Umbrella stand in epoxy coated steel with removable drip tray.	Black, Metallic Grey or White	\$1,115.00

### MCU

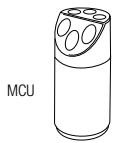

MCU

MODEL	H	W	D	SHIPPING WEIGHT	DESCRIPTION	COLOR/ FINISH	LIST PRICE
MCU	19 1/2"	10"	10"	8 lbs.	Holds 6 umbrellas (3 small, 3 large)	Black or Grey ABS plastic	\$340.00

### PLATEA



PLATEA

MODEL	H	W	D	SHIPPING WEIGHT	DESCRIPTION	COLOR/ FINISH	LIST PRICE
PLATEA	19 5/16"	11 7/16"	Ø	8 lbs.	Umbrella stand for all sizes of umbrellas. Includes easily removable drip tray.	Chrome with drip tray in Aluminum Ral 9006.	\$475.00

### FORREIN



FORREIN

MODEL	H	W	D	SHIPPING WEIGHT	DESCRIPTION	COLOR/ FINISH	LIST PRICE
FORREIN	19 13/16"	12 13/16"	9 7/16"	15 lbs.	Umbrella stand with polyethylene base.	Textured White, Textured Black Ral 9011 or Textured Forge Grey	\$415.00

### DROP-IN



DROP-IN-02

MODEL	H	W	D	SHIPPING WEIGHT	DESCRIPTION	COLOR/ FINISH	LIST PRICE
DROP IN-01	18 7/8"	15 3/8"	7 1/16"	15 lbs.	Umbrella stand with removable drip tray.	Textured White, Textured Black Ral 9011 or Textured Forge Grey	\$435.00
DROP IN-02	19 15/16"	16 3/8"	7 1/16"	18 lbs.	Umbrella stand for long umbrellas with integrated bin for shorter umbrellas. Removable drip tray.	Textured White, Textured Black Ral 9011 or Textured Forge Grey main bin. Integrated bin available in White, Black, Forge Grey, Satin Grey Beige Ral 1019 or Satin Mustard Ral 1012.	\$695.00

## CONEE

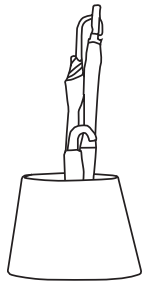

CON-UMB

MODEL	H	W	D	SHIPPING WEIGHT	DESCRIPTION	COLOR/ FINISH	LIST PRICE
CON-UMB	11 7/16"	15"	Ø	15 lbs.	Painted umbrella stand with wire separators to hold umbrellas	Textured Black Ral 9011, Textured White or Textured Grey	\$1,075.00

(See page 52 for matching planter and page 62 for matching waste can.)

(Product available late fall 2016)

## SOU

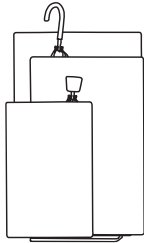

SOU-FLR

MODEL	H	W	D	SHIPPING WEIGHT	DESCRIPTION	COLOR/ FINISH	LIST PRICE
SOU-FLR	24 1/4"	15 1/2"	5 3/4"	23 lbs.	Painted steel umbrella stand for both tall and short umbrellas. Base and middle panel can be painted contrasting color. Drip trays for both tall and short umbrellas included.	Textured Black Ral 9011, Textured White, Mustard Ral 1012, or Grey Beige Ral 1019 for middle panel and base, Exterior panels in Textured Black Ral 9011 or Textured White.	\$895.00

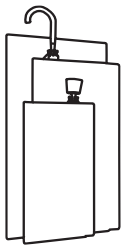

SOU-WALL

SOU-WALL	24 1/4"	15 1/2"	5 1/4"	21 lbs.	Wall mounted painted steel umbrella stand for both tall and short umbrellas. Middle panel can be painted contrasting color. Drip trays for both tall and short umbrellas included.		\$895.00
----------	---------	---------	--------	---------	--	--	----------

Model Prefix	Model Name Product Category	PL Pages
10xx	1000 Series Magazine & Literature Displays .....	78
20xx	2000 Series Magazine & Literature Displays .....	79
21xx	2000 Series Magazine & Literature Displays Chart Holders .....	80
400x	Infomera information & Graphic Displays .....	86
70xx	7000 Series Magazine & Literature Displays .....	82
ARNAGE	Arnage Poster Displays .....	94
ARNAGE	Arnage White Boards .....	96
ARNAGE	Arnage Coat Racks - Free Standing & Wall Mounted .....	117, 121
AX	Axiane Waste & Recycling Receptacles - Desk Side .....	43
AX	Axiane Desktop Accessories .....	61, 64
BAL	Balloon Waste & Recycling Receptacles - Exterior .....	45
BAMBU	Bambu Coat Hooks, Hook Panels & Hook Strips .....	105
BAMBU	Bambu Coat Trees .....	112
BAYU	Bayu-2 Umbrella Stands.....	123
BRANCH	Branch Coat Trees .....	115
CALMA	Calma Stools .....	65, 70
CARTBOX	Cartbox Message Boards.....	95-96
CB	Basics Waste & Recycling Receptacles - Desk Side .....	42, 63
CELES	CelesTables - Café & Occasional.....	68, 73
CIRCUS	Circus Coat Hooks, Hook Panels & Hook Strips .....	104
CLIMB	Climb Coat Hooks, Hook Panels & Hook Strips.....	110
CLM	CLM Series Coat Racks - Free Standing & Mobile.....	117
CON	Conee Waste & Recycling Receptacles - Desk Side.....	44, 62
CON	Conee Planters.....	52
CON	Conee Umbrella Stands.....	125
CREPE	Crepe Planters .....	50
CT	CooltimeTables - Café & Occasional.....	67
DACI	Dacapo IPoint - Brochure & Leaflet Holders .....	77
DC	Dacapo Brochure & Leaflet Holders .....	76
DRIP	Drip Umbrella Stands.....	124
DROP	Drop Waste & Recycling Receptacles - Desk Side .....	43, 64
DROP IN	Drop-In Umbrella Stands.....	124
DS	DS Series Coat Racks - Wall Mounted .....	116
DSF/DDF	DS Series Coat Racks - Free Standing & Mobile .....	119
EWC	EWC Series Coat Trees.....	112

Model Prefix	Model Name Product Category	PL Pages
FCL	Clamper Information & Graphic Displays .....	86
FILO	Filo Coat Hangers .....	121
FLAP	Flap Magazine & Literature Displays.....	83
FLOD	Flod Stools .....	65, 70
FLP	Flip Brochure & Leaflet Holders.....	75, 84
FORREIN	Forrein Umbrella Stands.....	124
FUM	Fum Outdoor Ashtrays.....	74
GINLET	Ginlet Stools .....	66
GL	Green Cloud Planters .....	51
GLN	Glassnox Information & Graphic Displays.....	87-89, 94
HELIX	Helix Coat Trees .....	115
HOLD	Hold Workspace & Collaborative Carts.....	53-54
HULOT	Hulot Coat Trees .....	114
IFLAG	IFlag Magazine & Literature Displays .....	83, 87
IPLU	Lumo IPoint Poster Displays.....	90
ISI	Isidoro (Stool) Stools .....	67, 70
ISI	Isidora (Chair) Outdoor Seating & Tables .....	71
JUNO	Juno Coat Trees .....	112
K	K Series Stainless Steel Hook Strips Hook Panels & Hook Strips .....	109
K	K Series Coat Hooks, Hook Panels & Hook Strips .....	105-106
KAS	Kaskad Planters.....	49
KOBE	Kobe Series Coat Hooks, Hook Panels & Hook Strips .....	108
KOBE	Kobe Coat Trees.....	113
KOKU	Koku Magazine & Literature Displays.....	82, 100
KP	KP Screen Moveable Screens .....	97
KYO	Kyo Planters .....	50
LAURA	Laura Planters & Table .....	50, 68
LAURA	LauraTables - Café & Occasional .....	68
LINEA	Linea Coat Racks - Free Standing & Mobile .....	118
LSN	Lausanne Waste & Recycling Receptacles - Exterior .....	46
LUCIDO	Lucido Outdoor Seating & Tables .....	71
LUMO	Lumo Poster Displays .....	90
M	Magnetic Coat Hooks.....	103, 104
MAD	Magnedoor Poster Displays.....	91
MAGO	Mago Magnedoor Message Boards.....	96

Model Prefix	Model Name Product Category	PL Pages
MALVA	Malva Moveable Screens .....	97
MARS	Mars+ Coat Trees.....	112
MAS	Magnedoor Slim Poster Displays .....	92
MBT	MBT Coat Trees.....	113
MCU	MCU Umbrella Stands .....	124
MECORA	Mecora Waste & Recycling Receptacles - Exterior.....	46
MET	Aloes MET Coat Trees.....	113
MEW	Aloes MEW Coat Hooks, Hook Panels & Series Hook Strips .....	108
MG	Steel Hangers Coat Hangers .....	121
MG	Molded Polystyrene Hangers Coat Hangers.....	122
MG	Wood Hangers Coat Hangers.....	122
MILL	Mill Tables - Café & Occasional.....	68
MIRAC	Mirac Coat Hooks, Hook Panels & Hook Strips.....	104, 110
MIRAC	Mirac Coat Trees .....	114
MIRAC	Mirac Coat Hangers.....	121
MKT	Kyoto MKT Coat Trees .....	113
MKW	Kyoto MKW Coat Hooks, Hook Panels & Hook Strips .....	108
MPAM	MPAM Series Coat Hooks, Hook Panels & Hook Strips .....	109
MR	Mega Rak Coat Racks - Free Standing & Mobile.....	120
MYIW Series	Yin MYIW Coat Hooks, Hook Panels & Hook Strips .....	108
NINO	Nino Coat Hooks - Magnetic.....	104
NP	New Port Desktop Accessories .....	55-57
NUTA	Nuta Stools .....	66
NW	New Wave Desktop Accessories .....	58-59
NX	My Personal Recycler Waste & Recycling Receptacles Recycler - Desk Side.....	43, 64
OMB	OM Basic Outdoor Seating & Tables .....	71
ONA	Ona Coat Hooks, Hook Panels & Hook Strips .....	109
OR	Office Rak Coat Racks - Free Standing & Mobile .....	118
OXI	Oxi Bistrot Tables - Café & Occasional.....	69, 73
P	P 70/P100 Umbrella Stands.....	123
PALADINO	Paladino Coat Trees.....	114
PANTALLA	Pantalla Information & Graphic Displays.....	85
PC	Over Door Hooks, Hook Panels.....	107
PC	PC Series Coat Trees .....	112

Model Prefix	Model Name Product Category	PL Pages
PFX	Padfix iPad Displays.....	95
PI	PI Costumer Coat Trees.....	114
PI	PI Coat hangers .....	121
PIC	PIC Waste & Recycling Receptacles - Interior .....	39-40
PLATEA	Platea Umbrella Stands .....	124
PLN	Padline iPad Displays .....	95
POINTO	Pointo Coat Hooks.....	105
POST	Post Class Sorting Modules .....	102
PUP	Pup Waste & Recycling Receptacles - Desk Side .....	44, 62
REST	Rest Desktop Accessories.....	60
RETTO	Retto Waste & Recycling Receptacles - Exterior.....	44
RIGA	Riga Outdoor Ashtrays.....	44, 74
RIGA	Riga Umbrella Stands .....	123
RIGA	Riga Waste & Recycling Receptacles - Interior .....	36, 37, 44
RIVISTA	Rivista Stools .....	66, 70
RIVISTA	Rivista (Chair) Outdoor Seating & Tables .....	72
ROL	Roller Workspace & Collaborative Carts .....	54
RP	Relax Footrests .....	65
RR	Rap Rak Coat Racks - Free Standing & Mobile.....	118
SCOOOP	Scoop Magazine & Literature Displays.....	82
SECOND TREE	Second Tree Coat Trees .....	115
SEI	SEI Hook Strips.....	110
SET	Infoglass Information & Graphic Displays.....	89, 94
SHERLO	Sherlo Coat Racks - Free Standing & Mobile .....	121
SLP	Interior Slope/Waste Recycling Receptacles.....	24-29
SMOKE	Smoke Waste & Recycling Receptacles - Exterior.....	44
SMOKE	Smoke Outdoor Ashtrays .....	74
SNR	Snaprex Information & Graphic Displays .....	85, 94
SO	Sotare Waste & Recycling Receptacles - Interior .....	22-23
SOCC	Compact Soistes Brochure & Leaflet Holders.....	75, 84
SOCU	Cubic Soistes Magazine & Literature Displays.....	81
SOMS	Maginfo Slim Soistes Poster Displays .....	93
SORA	Rack Soistes Magazine & Literature Displays.....	81

Model Prefix	Model Name Product Category	PL Pages
SOU	Sou Umbrella Stands.....	125
SOWM	Wallmate Soistes Magazine & Literature Displays.....	81
SOZ	Solid Zip Brochure & Leaflet Holders.....	77
SP	Silo Umbrella Stands.....	124
SPB	Silo Waste & Recycling Receptacles - Desk Side.....	43, 64
SR/R1	Hanger Receptacles Coat Hangers.....	122
ST	Storlek Waste & Recycling Receptacles - Interior.....	30-31
STEP	Step Tables - Café & Occasional.....	69, 72
STICKS	Sticks Magnetic Coat Hooks - Magnetic.....	103
STICKS	Sticks Front Mount Coat Hooks.....	104
STICKS	Sticks HJH Hook Strips.....	110
STICKS	Sticks G+ Coat Trees.....	114
STIF	Maginfo Soistes Poster Displays.....	93
STIL	Stilla Chair Outdoor Seating & Tables.....	72
STILLY	Stilly Acoustic Wall Panels.....	75
STILO	Stilo Waste & Recycling Receptacles - Interior.....	41
STILO	Stilo Planter.....	52
STOP	Stopper Eco Crowd Control Stanchions.....	101
STORE	Store Workspace & Collaborative Carts.....	52
SUM	Sum Wall-Mounted Tool Rail Desktop Accessories.....	55
SUP	Phone/Tablet/Laptop Supports Desktop Accessories.....	62
T	Tertio Magnetic Coat Hooks - Magnetic.....	102
T	Tertio H-K Coat Hooks, Hook Panels & Hook Strips.....	107
T	Tertio HJH Coat Hooks, Hook Panels & Hook Strips.....	111
T	Tertio W2Coat Racks - Free Standing & Mobile.....	117
T	Tertio Coat Racks - Free Standing & Mobile.....	120

Model Prefix	Model Name Product Category	PL Pages
TAIGA	Taiga Coat Trees.....	115
TAIGA	Taiga Umbrella Stands.....	123
TOTEM	Totem Shelving/Bookshelves.....	99
TPL	Tempaline Crowd Control Stanchions.....	100
TR	Sortmate Waste & Recycling Receptacles - Desk Side.....	42, 63
TRADA	Trada Waste & Recycling Receptacles - Interior.....	38
TREE	Treehooked Coat Hooks, Hook Panels & Hook Strips.....	104
TUB	Tubulus H Coat Hooks, Hook Panels & Hook Strips.....	104
UMEA	Umea Waste & Recycling Receptacles - Interior.....	32-35
UMEA	Umea Waste & Recycling Receptacles - Exterior.....	47-48
USIO	Usio Magazine & Literature Displays.....	83, 100
VA	Pictor Showcases.....	98
VA	Valuta/Interior Waste & Recycling Receptacles.....	20, 21
VACANZA	Vacanza Outdoor Seating & Tables.....	71
VE	Vesuvio Outdoor Ashtrays.....	74
VOICI	Voici Magazine & Literature Displays.....	82
XYLO	Xylo Coat Trees.....	113
YIN	Yin Under Table Purse Hooks.....	104
YIN	Yin Umbrella Stands.....	123
YIN	Yin Coat Trees.....	113
ZED	Zed Stools.....	65
ZIN	Zin Magazine & Literature Displays.....	84
ZUR	Zurich Waste & Recycling Receptacles - Interior.....	41



# The Magnuson Group Environmental Statement

Magnuson Group recognizes the importance of being good stewards to the earth. We incorporate positive environmental processes into all facets of the company. Whether the process is administrative in nature, or is in manufacturing, Magnuson strives to ensure that environmental concerns are made a part of the system. Some specifics include:

- All steel scrap is 100% recycled
- All aluminum scrap is 100% recycled
- All wood scrap generated in manufacturing is used in energy production in a co-generation plant
- All paper and packaging waste is 100% recycled

## Indoor Advantage Gold certification (SCS)

Advantage Gold certification is SCS Global Services' highest level of indoor air quality performance for meeting strict chemical emission limits for volatile organic compounds (VOCs). To be certified, products must be tested by independent labs for compliance with the ANSI/BIFMA X7.1, and either ANSI/BIFMA e.3 or CDPH/EHLB Standard Method V1-1 for VOC emissions of concerns.

## US Green Building Council (USGBC)

Magnuson Group is a proud member of the US Green Building Council (USGBC), which supports the advancement of the latest in innovative building practices & minimalizing environmental impact for a more sustainable built environment.

## The following is submitted as the typical use of various commodities:

- Steel - is manufactured with 30-40% post consumer material and is 100% recyclable
- Wood products - are certified to be 100% from a sustainable forest
- Plastics - are 100% recyclable
- Fabrics - are manufactured from 100% post consumer materials, and is fire rated to:  
ASTM E-84 Class 1 or A

## We certify that there is no asbestos in any of the products we manufacture or import for sale.

- Aluminum - comes from 10-20% post consumer material and is 100% recyclable
- Packaging - comes from a minimum of 35% post consumer material and is 100% recyclable
- Paint (powder coating) - All paints used are certified to be of low VOC content < 50g per liter. They emit no hazardous air pollutants (HAP) or noxious fumes when exposed to fire NFPA 704 Health = 1, Fire = 1, Reactivity = 0.
- Imports - We import products from various countries in Europe. Most but not all are certified ISO 9001 -14001 Environmental Management Systems. Please contact us if you need further information.
- Paper - All paper and packaging waste is 100% recycled.
- Plating - Plating is kept to the absolute minimum. Our plater's meet or exceed all Illinois EPA, Federal EPA, and OSHA mandated standards; all plating is RoHS compliant. Our plating emits no hazardous air pollutants (HAP) or noxious fumes when exposed to fire.

